



Casa de Teresa



Wow — you're building my house! Seems a little small doesn't it?



Build Barbie And Her Friends' Homes!

- A: Barbie Dreamhouse**
- B: House of Ken**
- C: The Raquelle Mansion**
- D: House of Nikki**
- E: The Ryan Mansion**
- F: Casa de Teresa**

Your house will look like this:





Casa de Teresa

INSTRUCTIONS

1. Use safety scissors to cut around the solid black lines.
Ask a grownup if you need help.



2. Fold along the dotted lines.

3. Glue tabs in number order on buildings 1, 2 and 3.

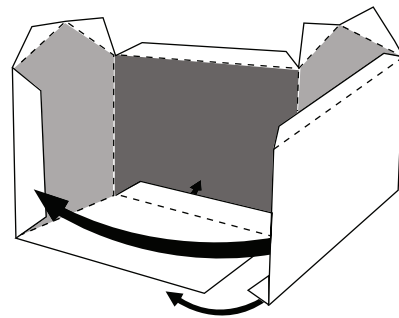

4. Once buildings are dry, affix roofs 1, 2 and 3 as well as turret pieces.

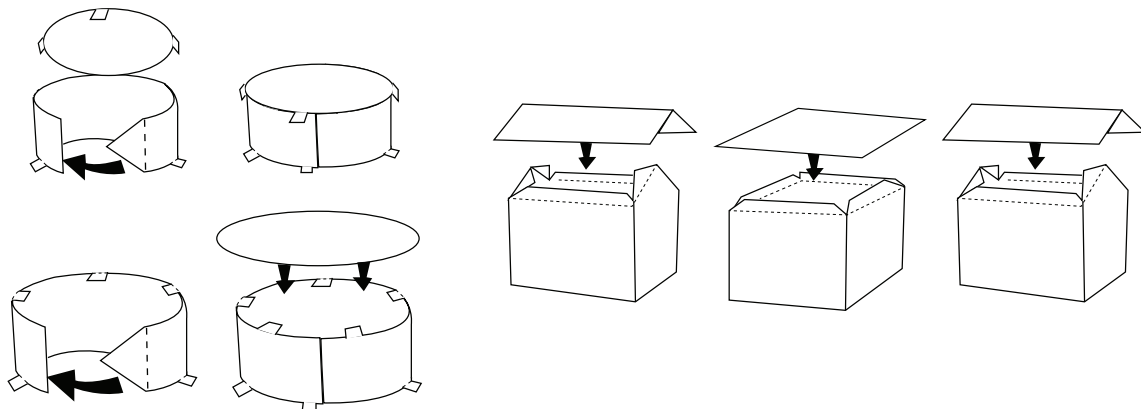

5. Glue buildings 1, 3 and turret pieces to building 2. When dry, glue to base.

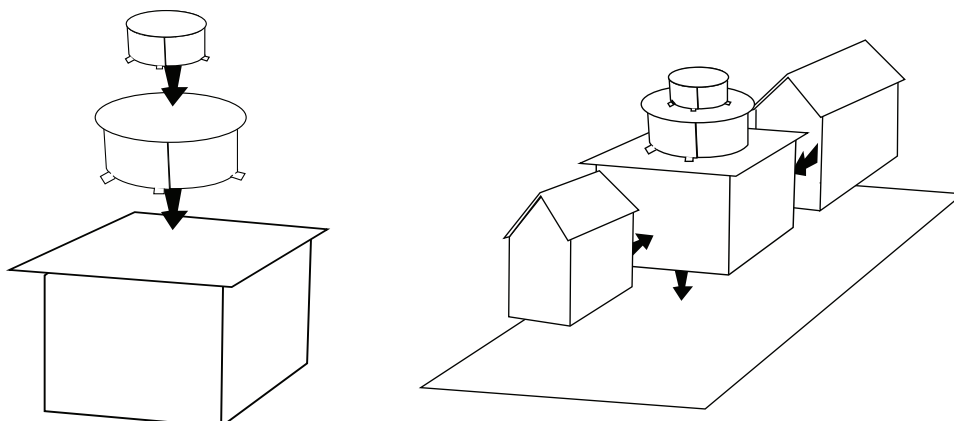



Casa de Teresa

BUILDINGS 1 & 2 AND ROOFS 1 & 2

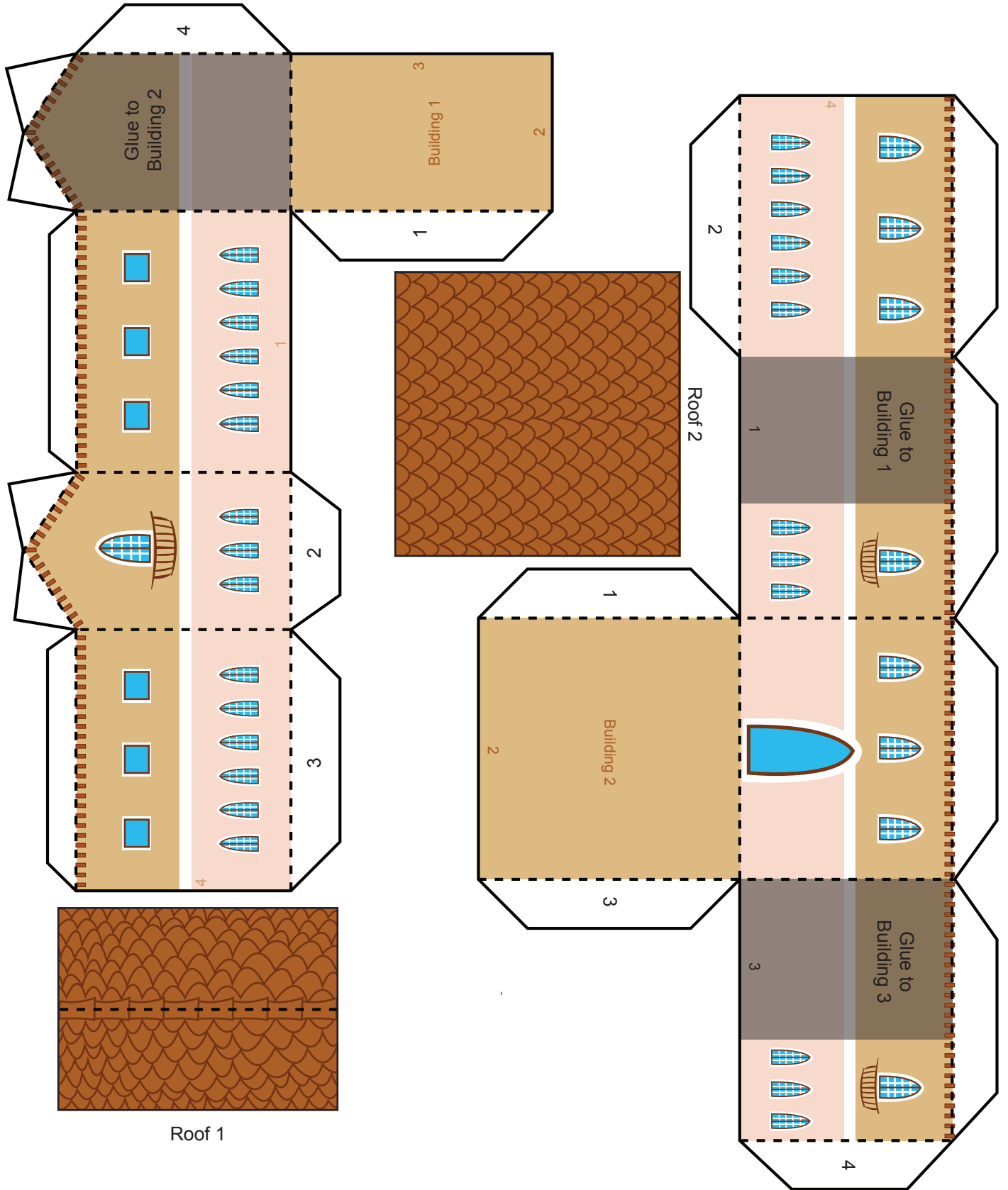



Casa de Teresa

BUILDING 3 & TURRETS

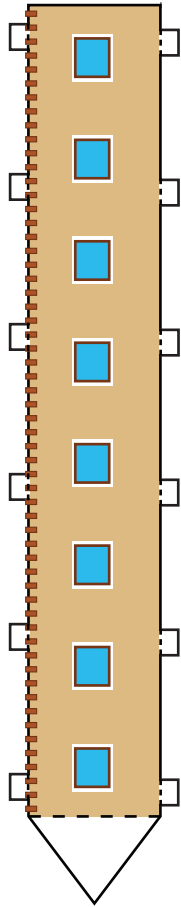

Turret 1
(Bottom)

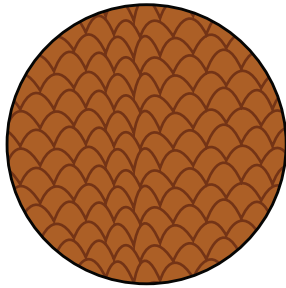

Turret 1 Roof

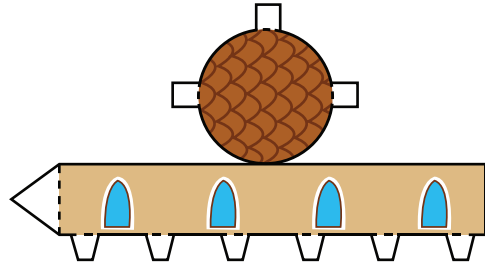

Turret 2 (Top)

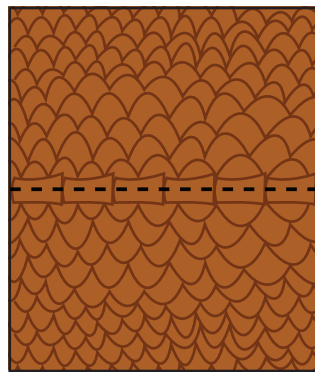

Roof 3

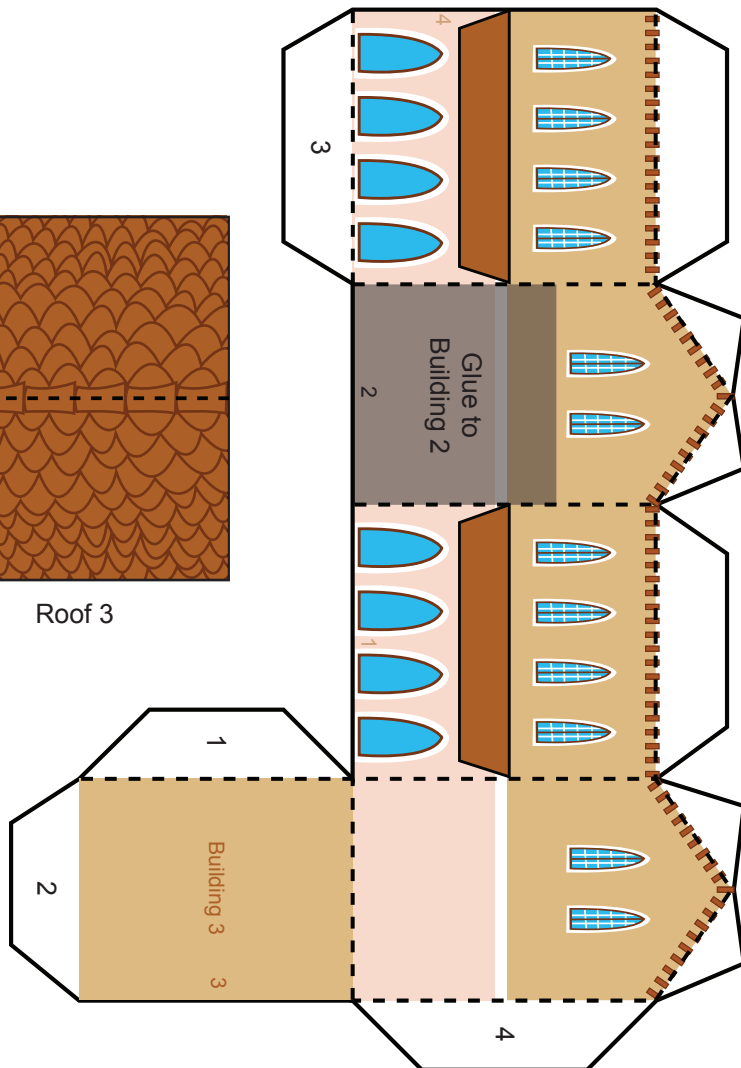



Casa de Teresa

BASE

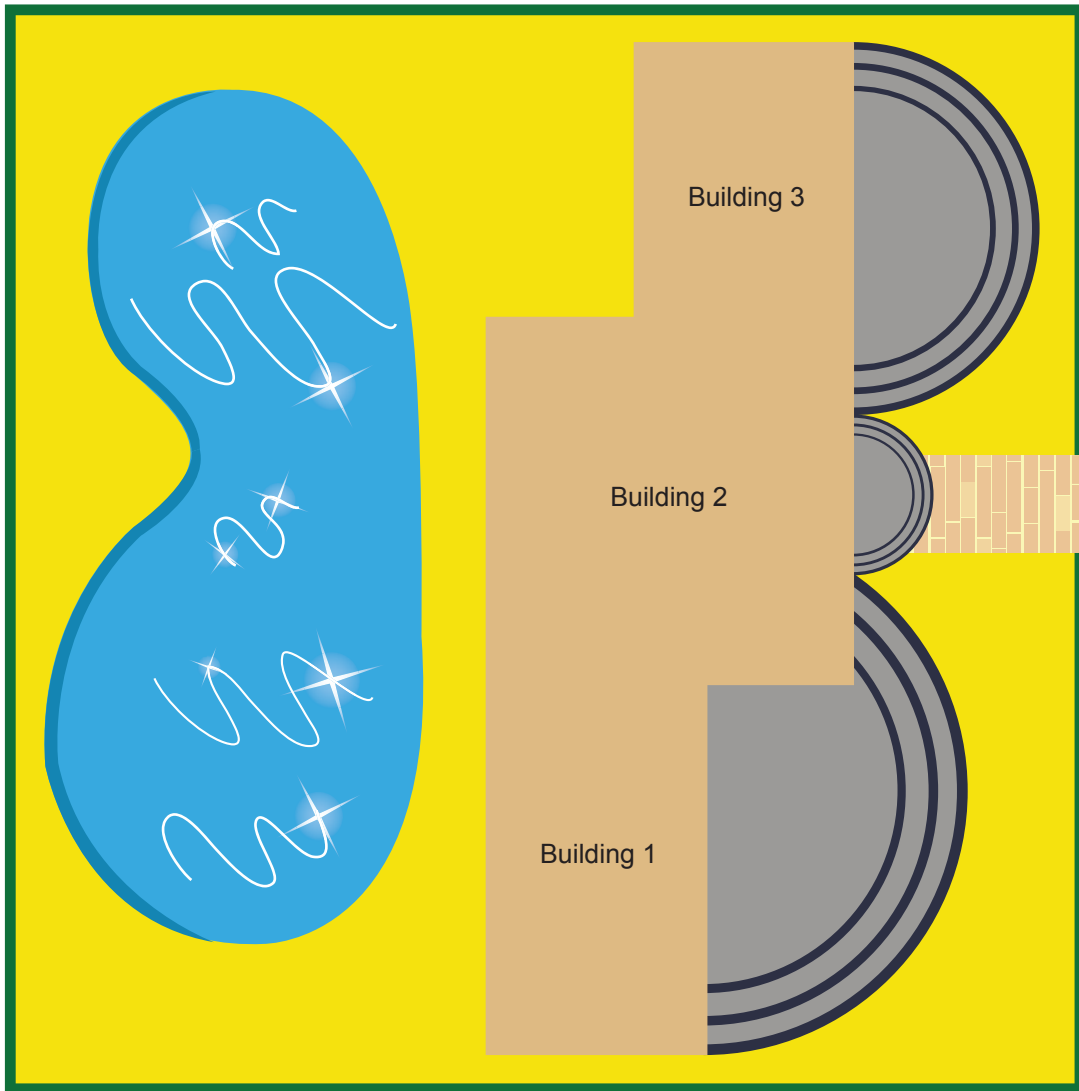



Teresa

INSTRUCTIONS

1. Use safety scissors to cut out Teresa. Ask a grownup if you need help.
2. Cut along the solid lines and fold on the dotted lines.

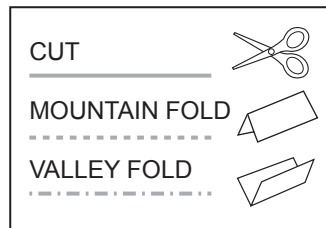

3. Glue or tape together the front and back of the play pieces.

Your Teresa will look like this:

