



Table of Contents

SECTION	PAGE
1. Characters	1
2. Locations	17-49
3. Gadgets and Gizmos	50-74

Prep & LANDING

Characters

WAYNE

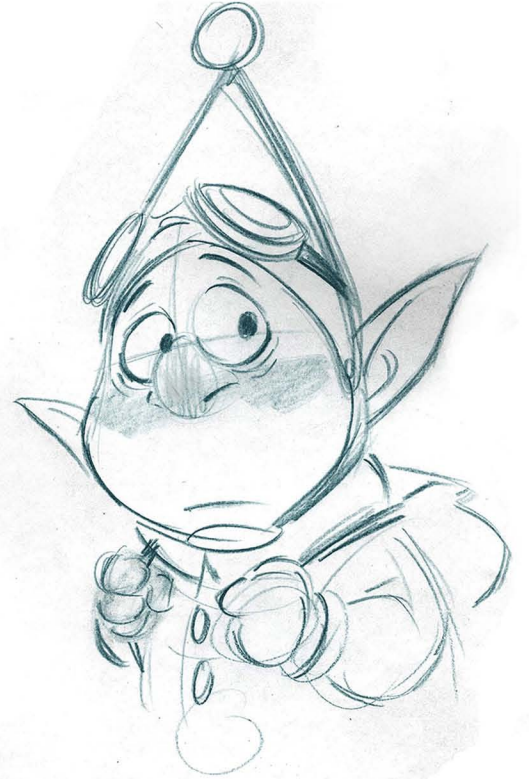

LANNY

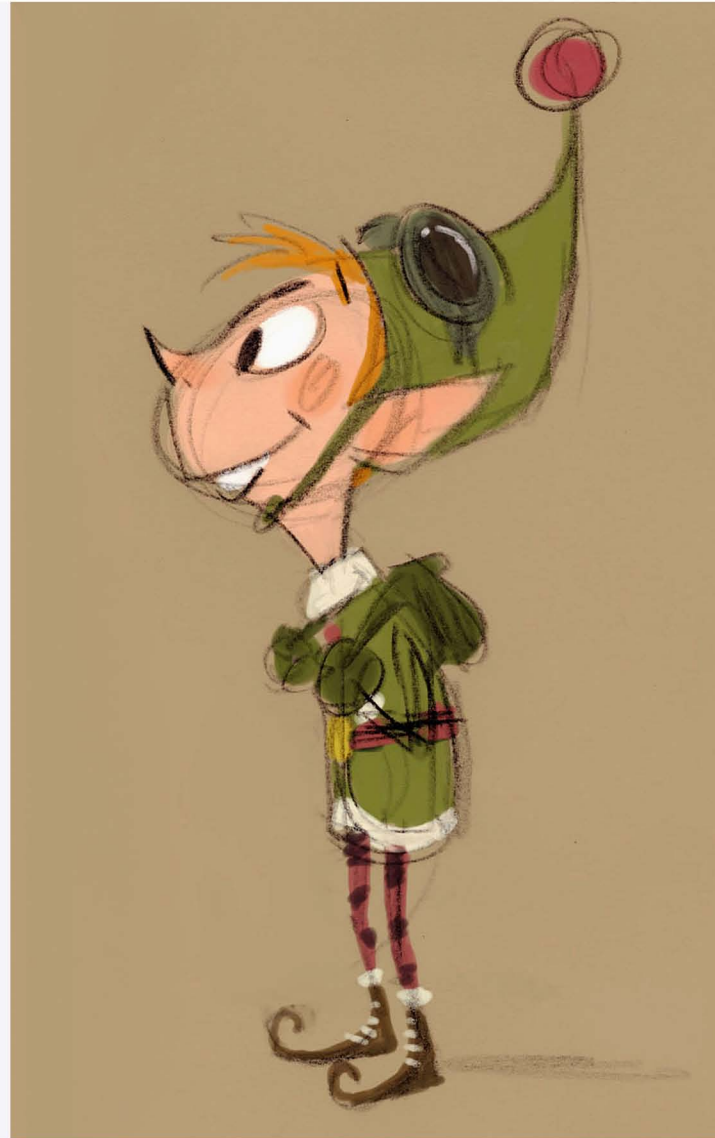

WAYNE & LANNY



MAGEE



MR. THISTLETON



TIMMY



JINGLESMELLI337-GRACE

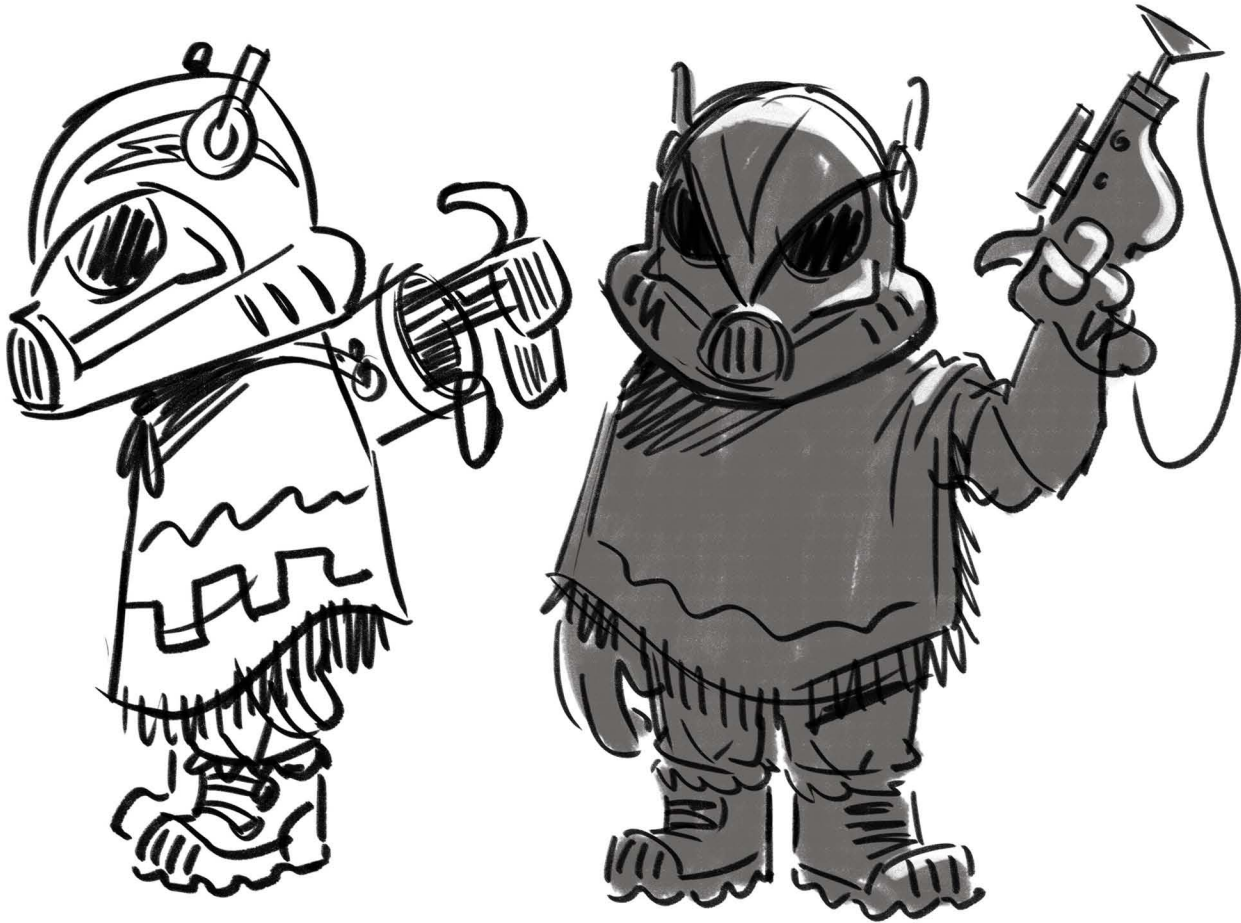

GRACE GOODWIN



Grace



HOP WITH ME BUNNY

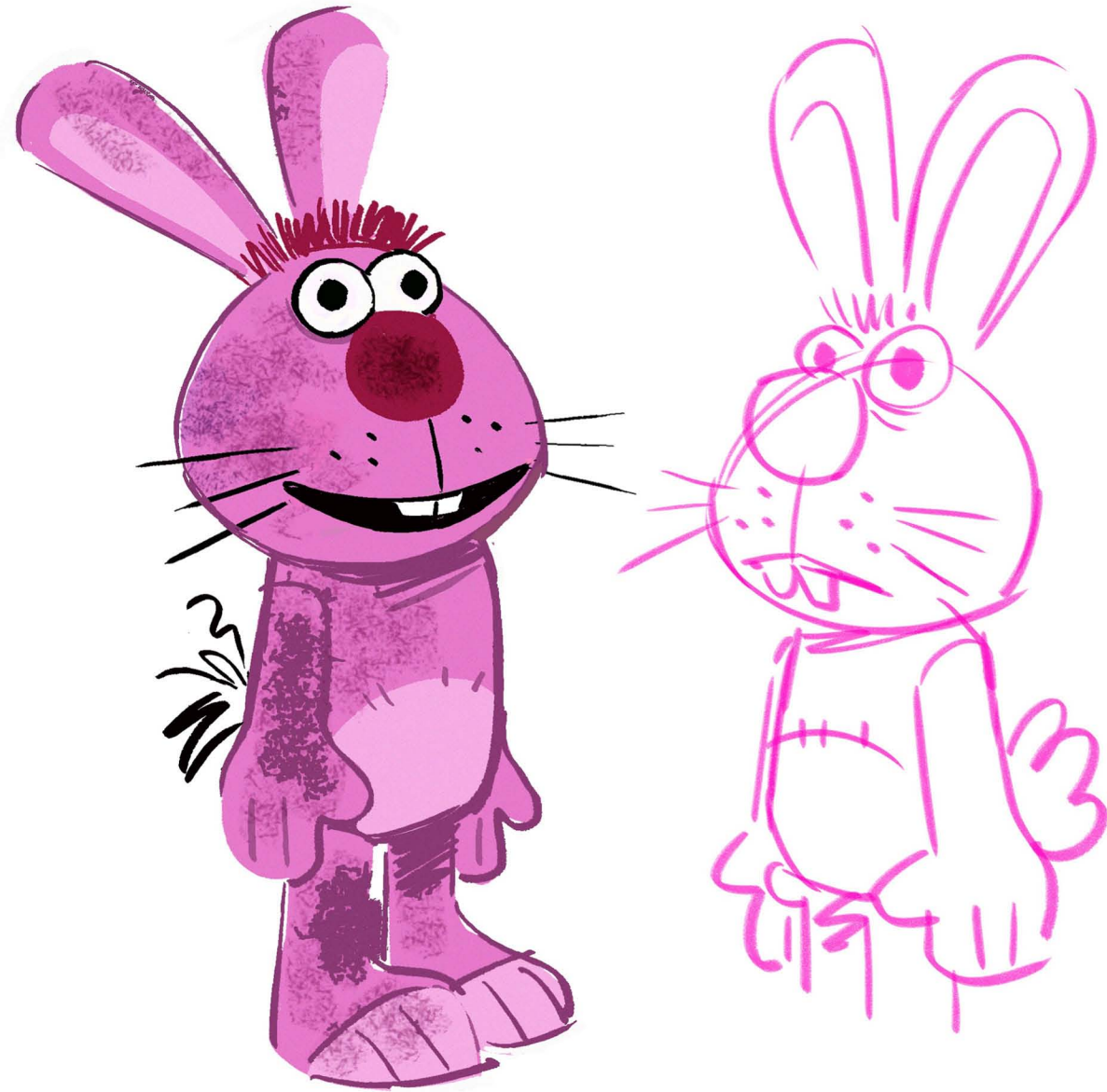

GABE GOODWIN



THRASHER

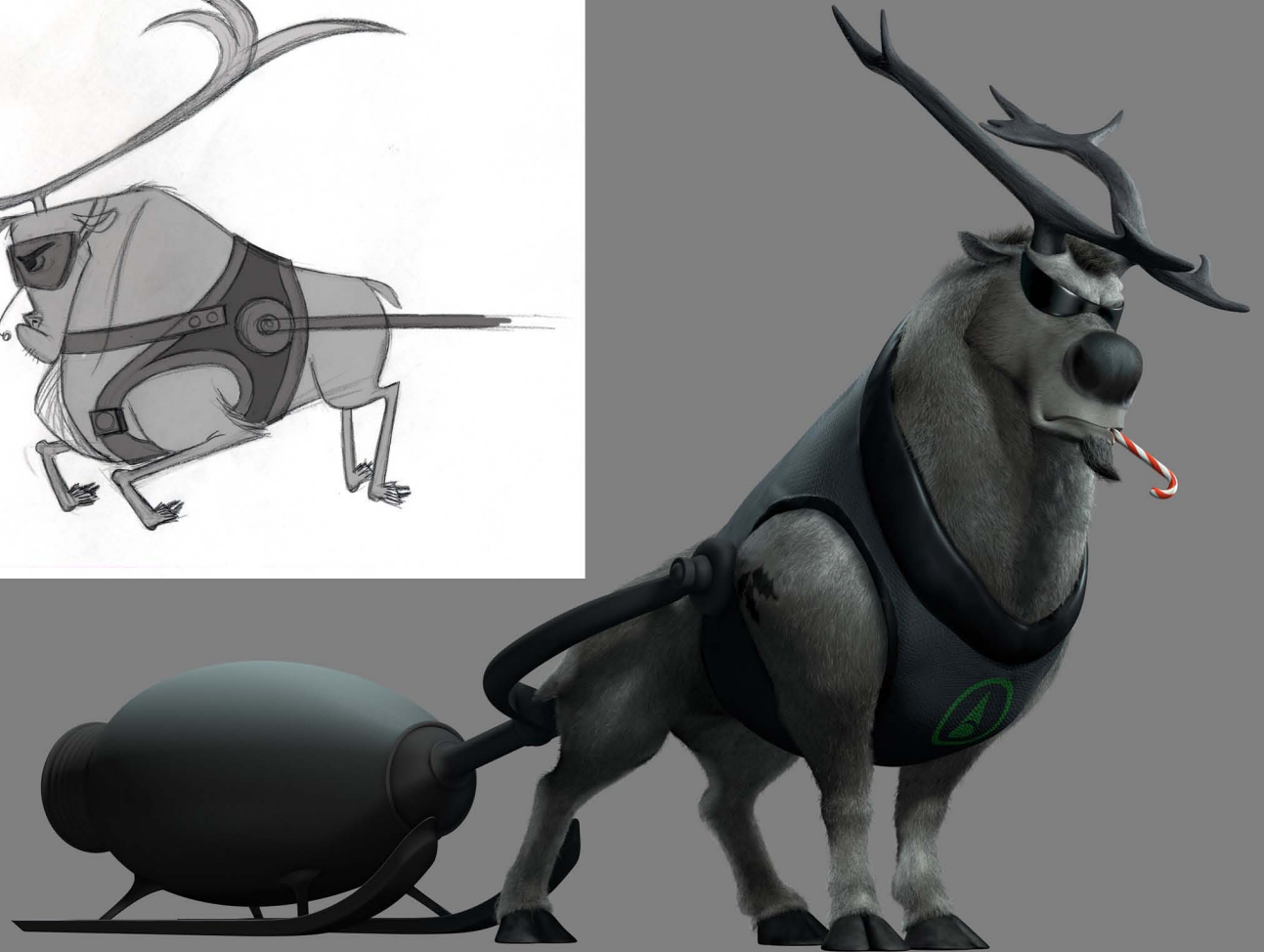

NOEL



CAROL



COAL ELVES



LAUNCH PAD ELVES



Prep & LANDING

Locations

GRACE'S APARTMENT



GABE'S NURSERY



GRACE'S ROOM



TIMMY'S HOUSE



TIMMY'S HOUSE



DOWNTOWN

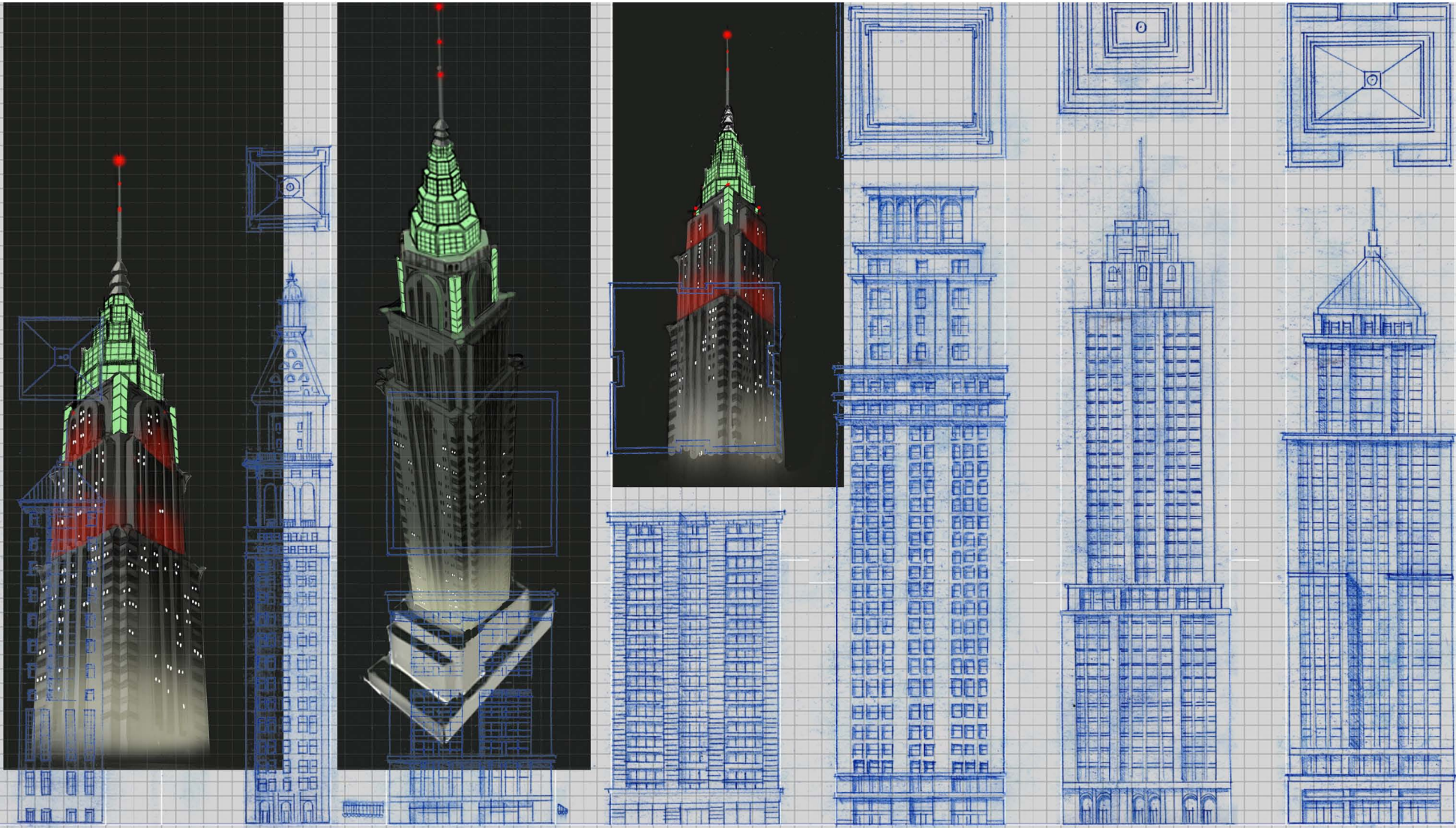

NORTH POLE



NORTH POLE

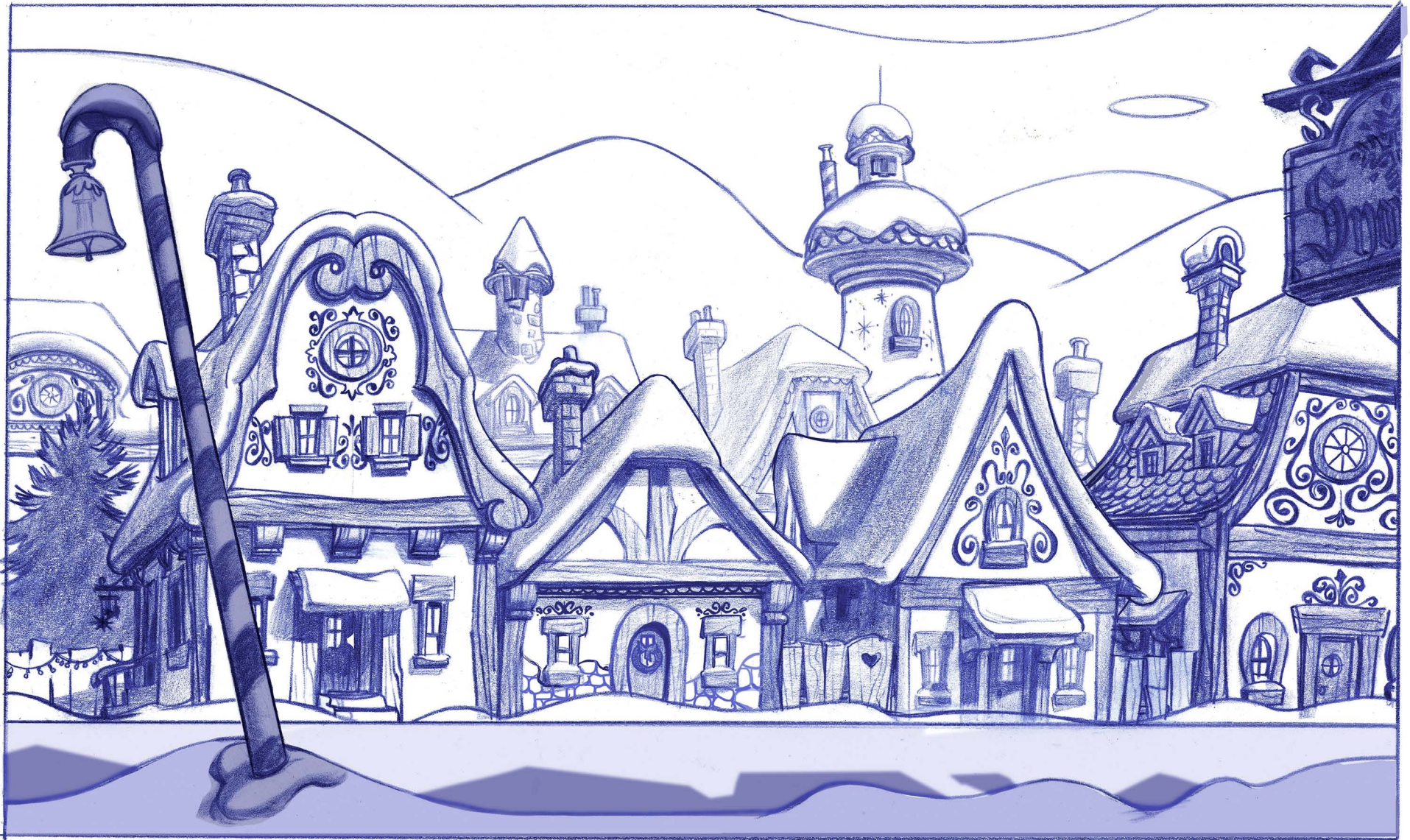

NATALE DEALERSHIP

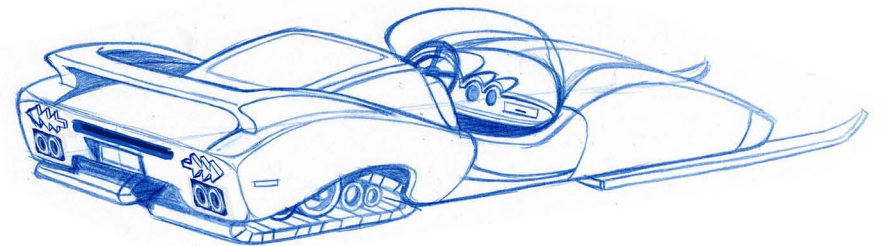
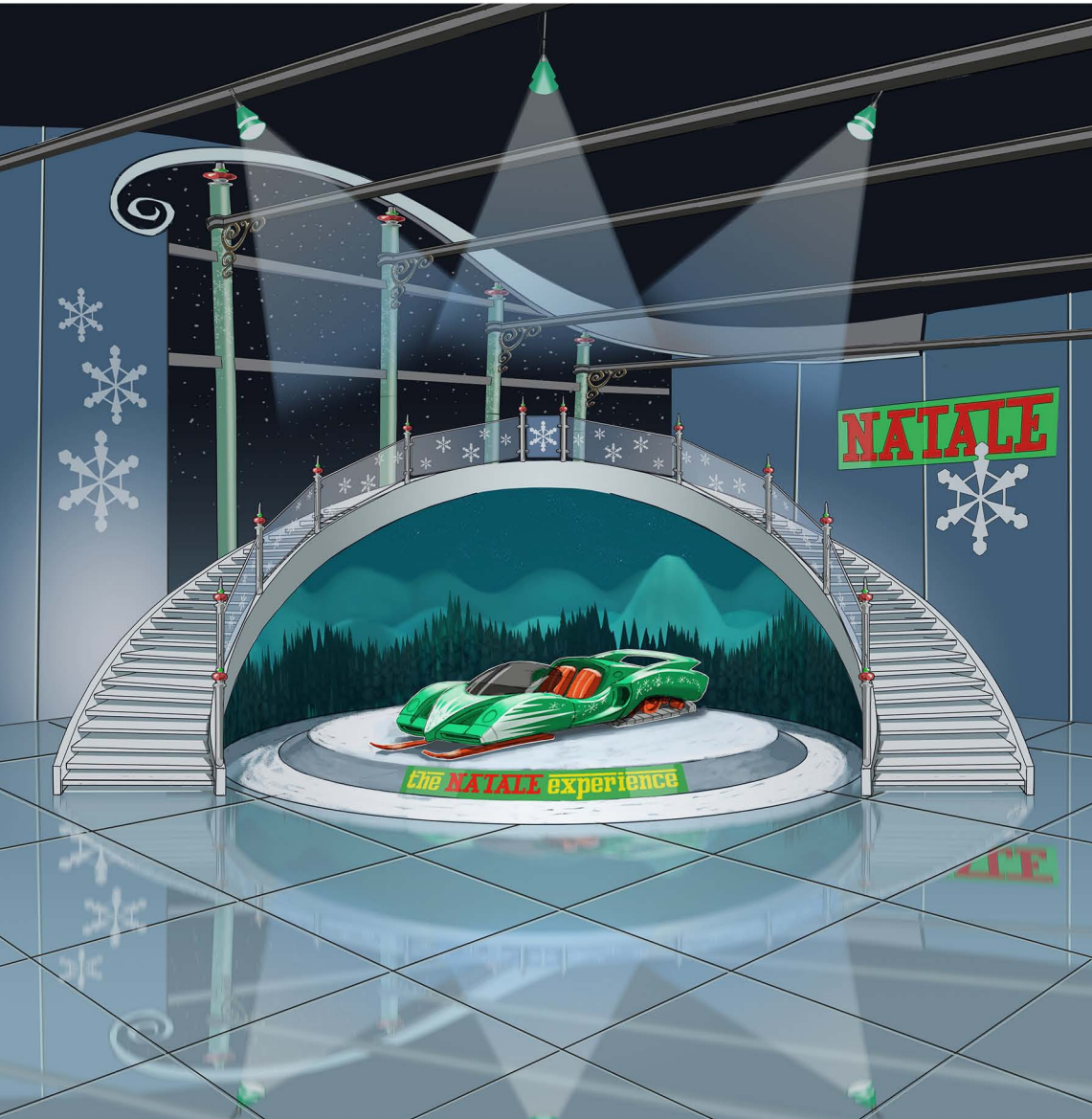

MISSION CONTROL

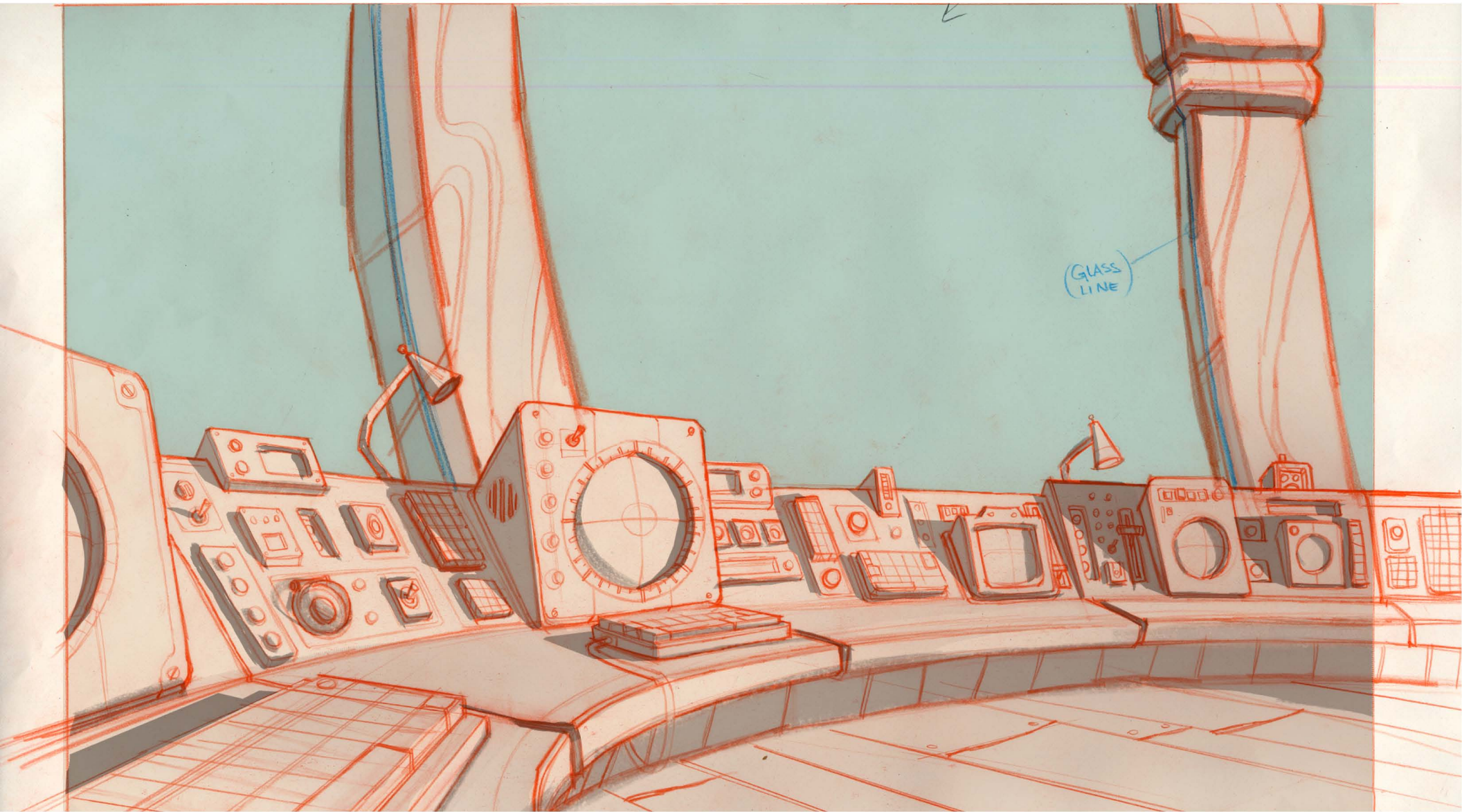

MISSION CONTROL

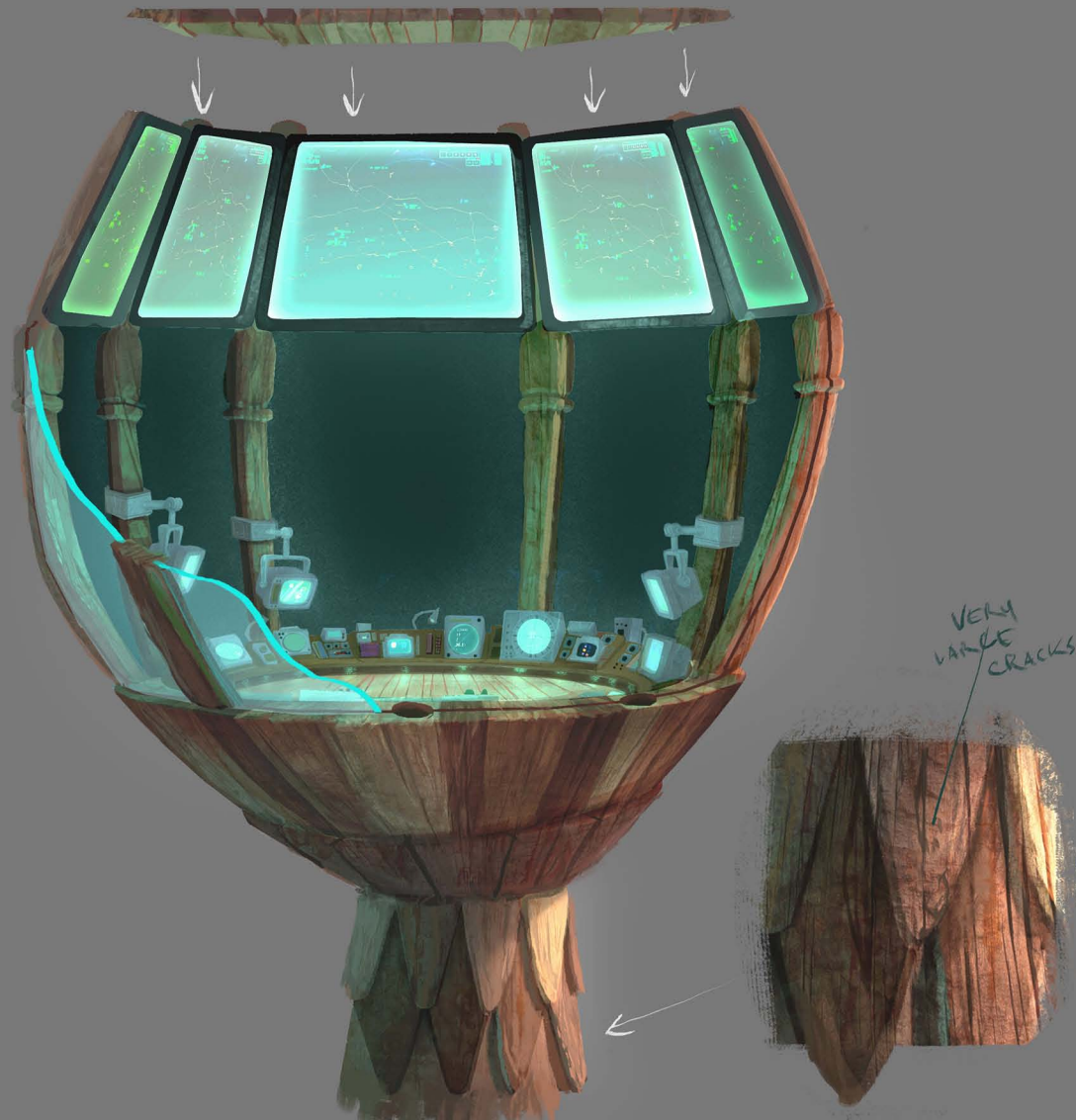

DATABASE TREE FARM



SITUATION ROOM

SITUATION
ROOM

(WEST)

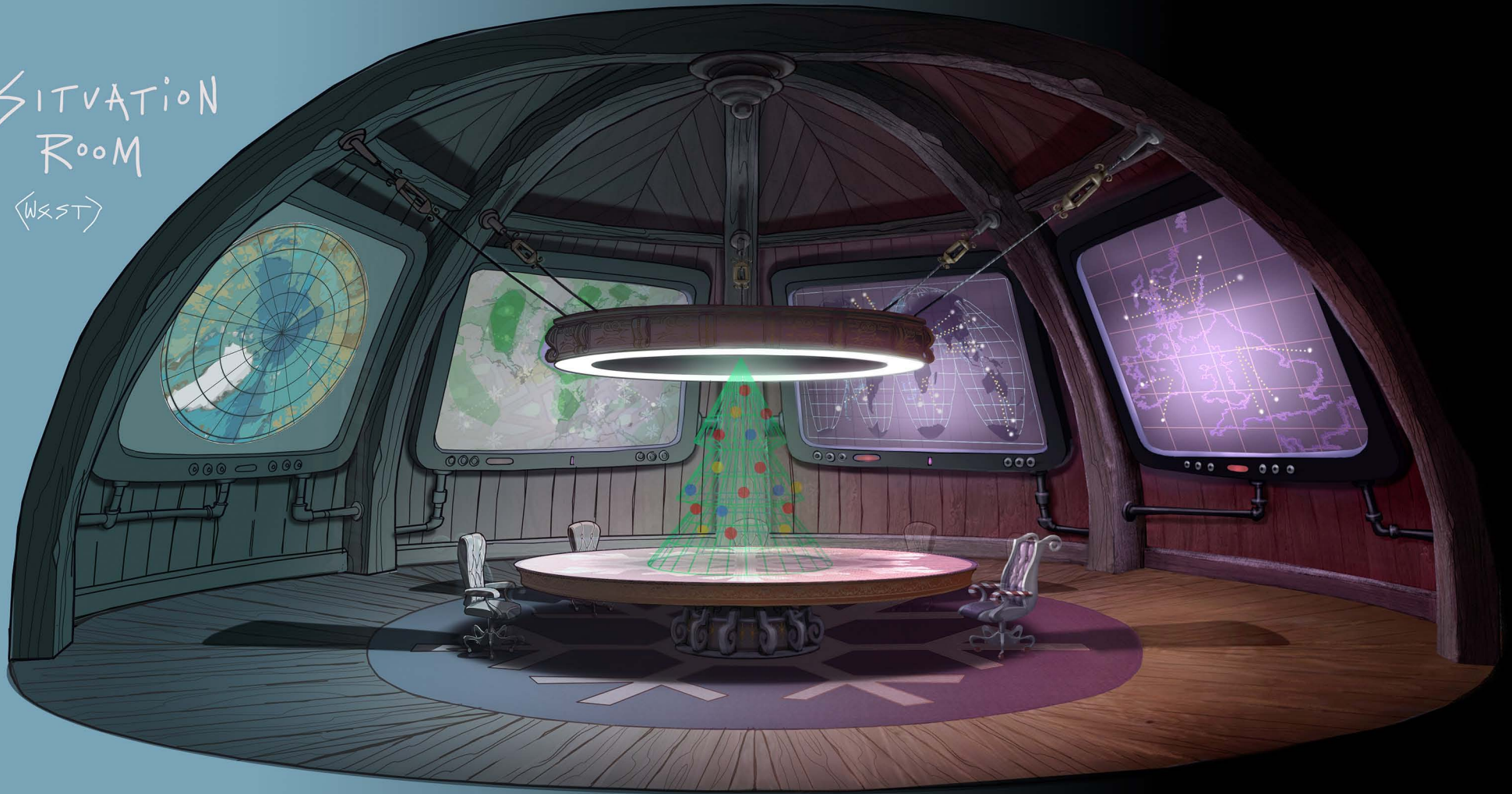

THISTLETON'S OFFICE



MAGEE'S OFFICE



SANTA'S OFFICE



SANTA'S OFFICE



SANTA'S OFFICE

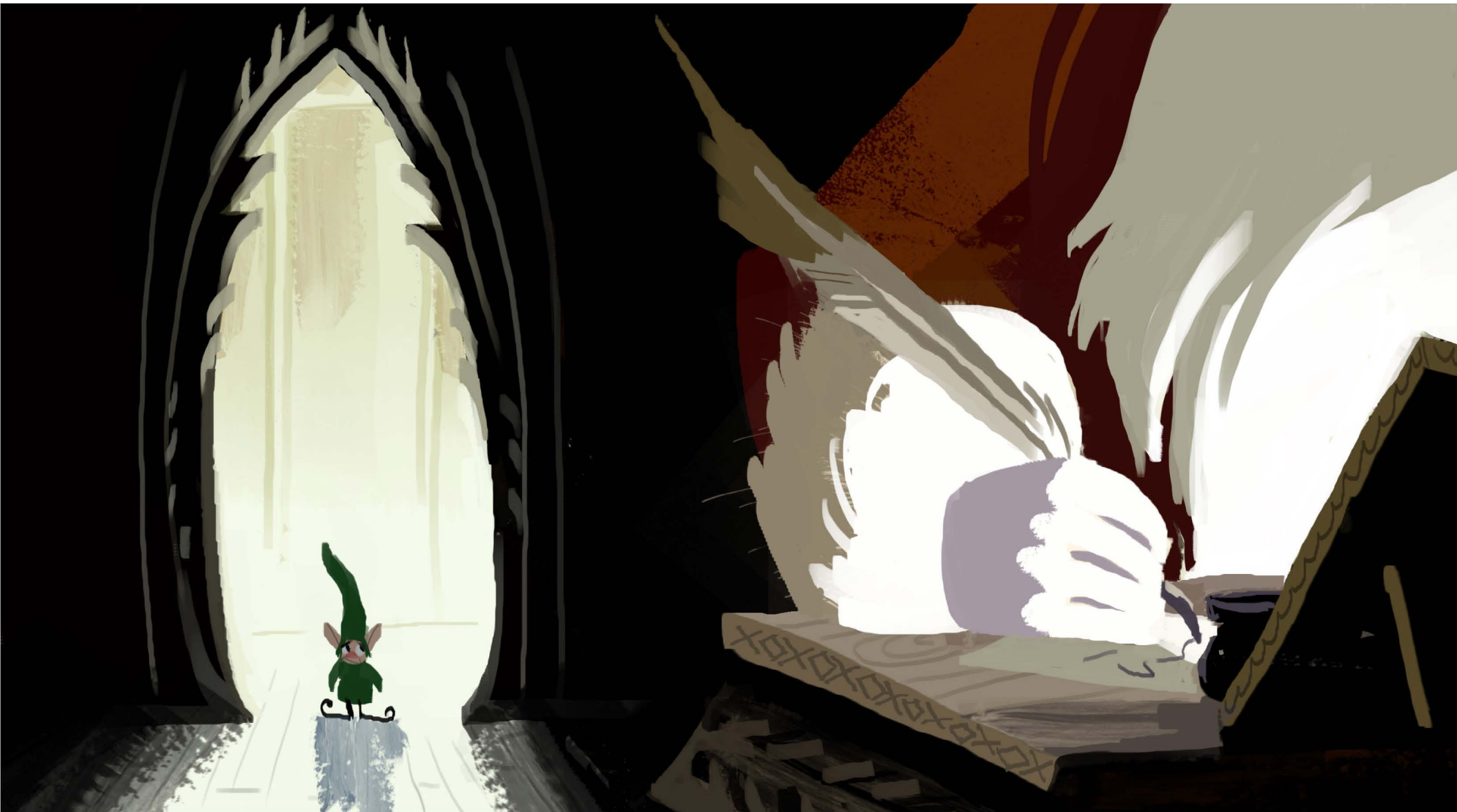

SANTA'S WORKSHOP



SANTA'S WORKSHOP

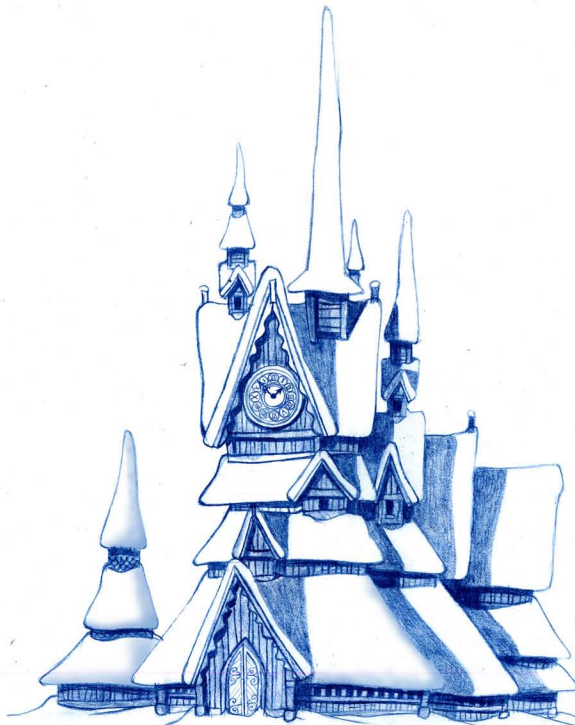
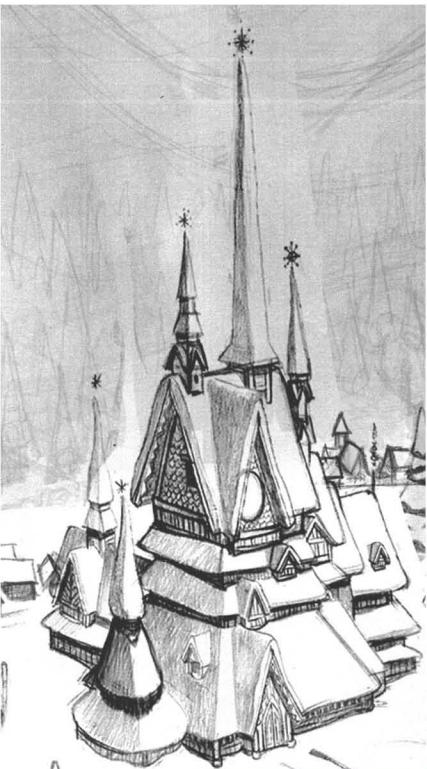

SANTA'S WORKSHOP

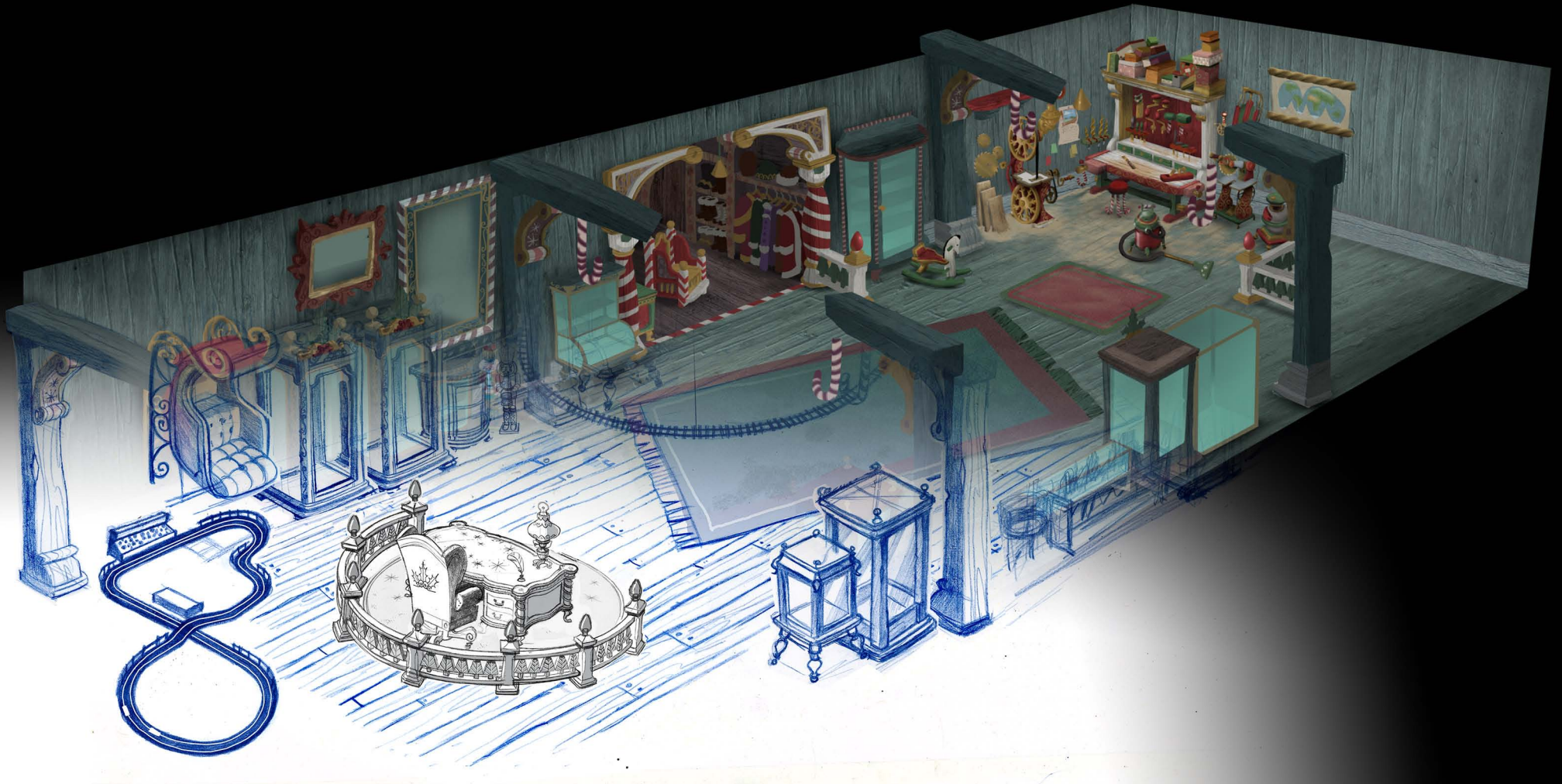

SANTA'S WORKSHOP



SANTA'S WORKSHOP

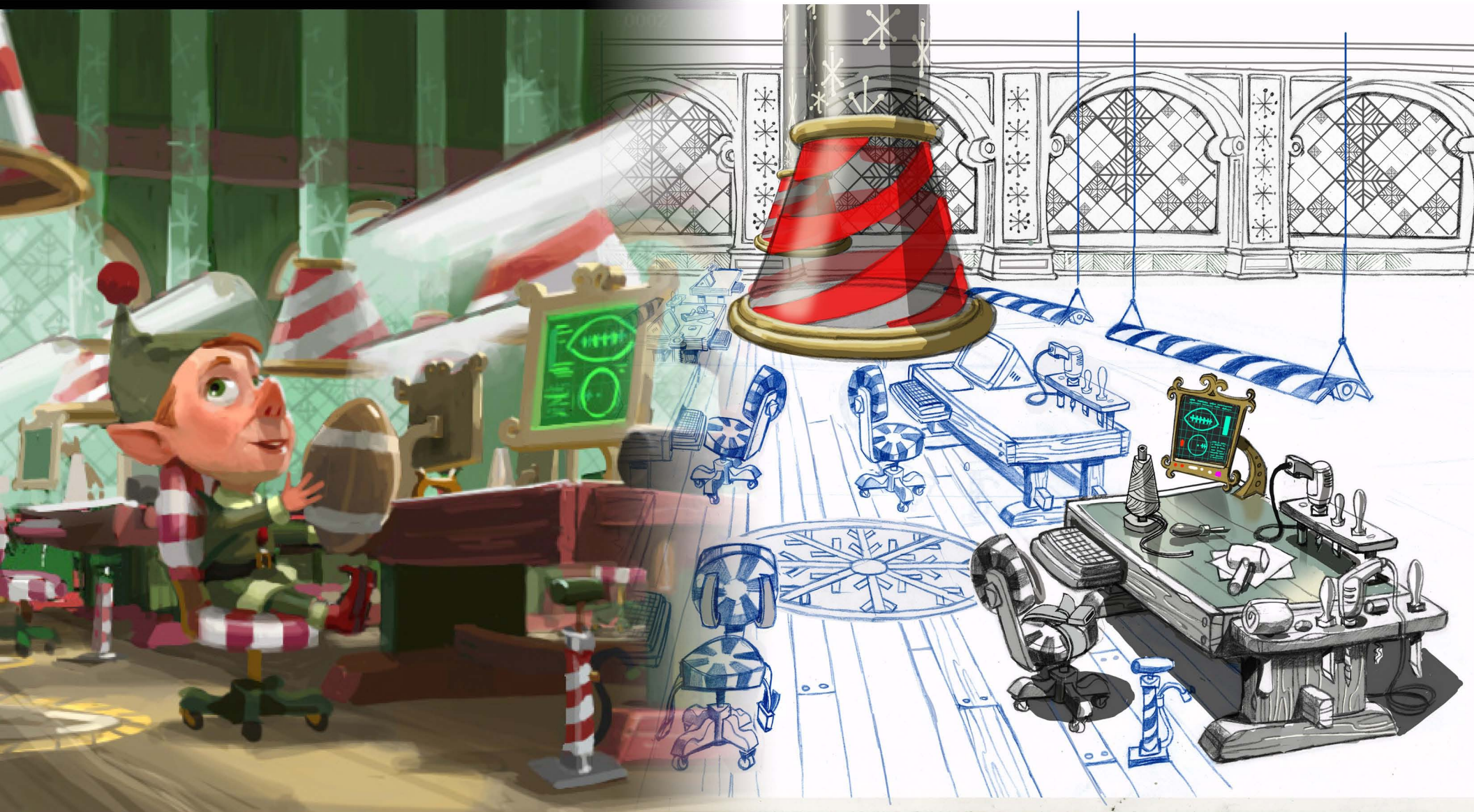

LAUNCH ROOM



LAUNCH ROOM



LAUNCH ROOM

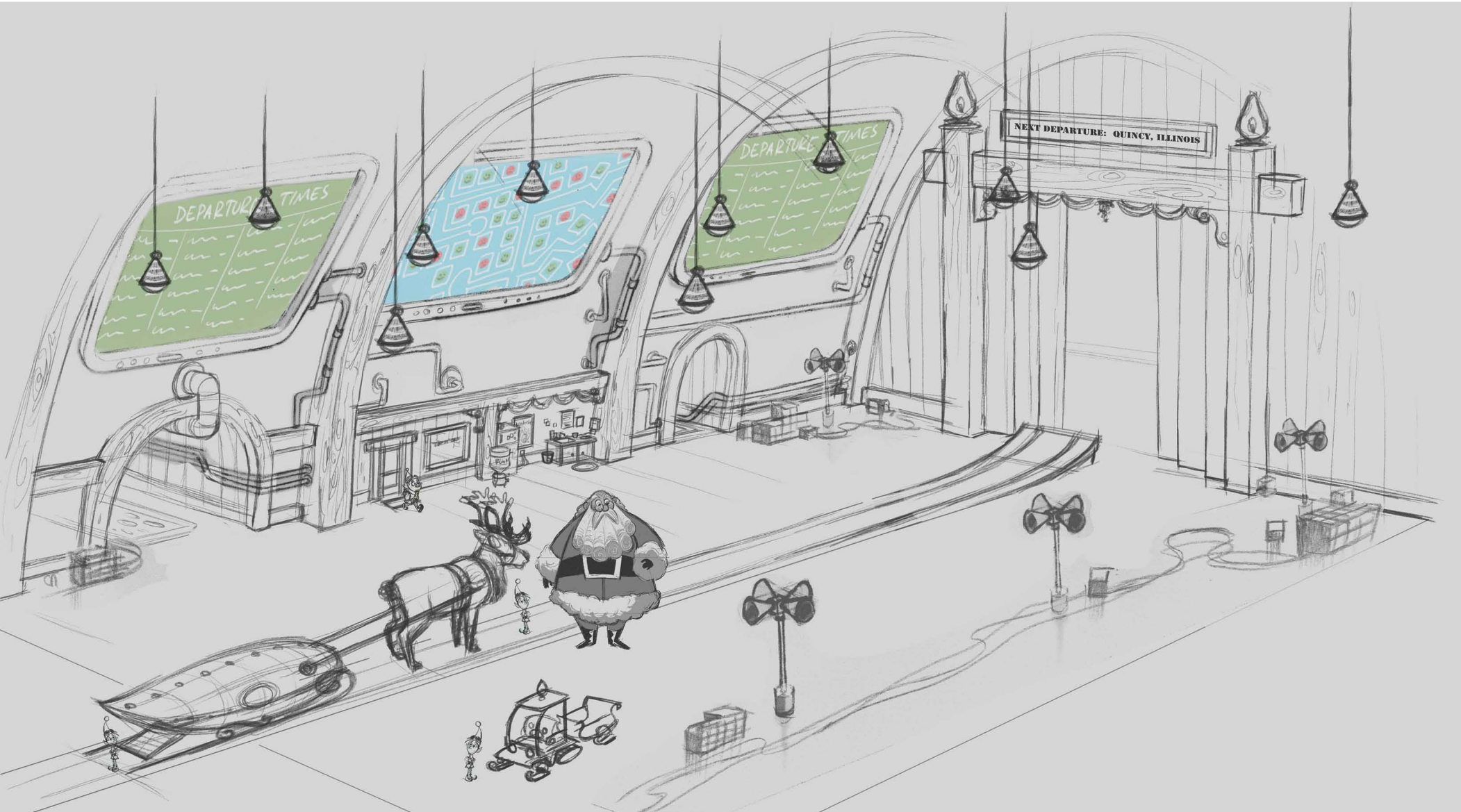

COAL DISTRICT

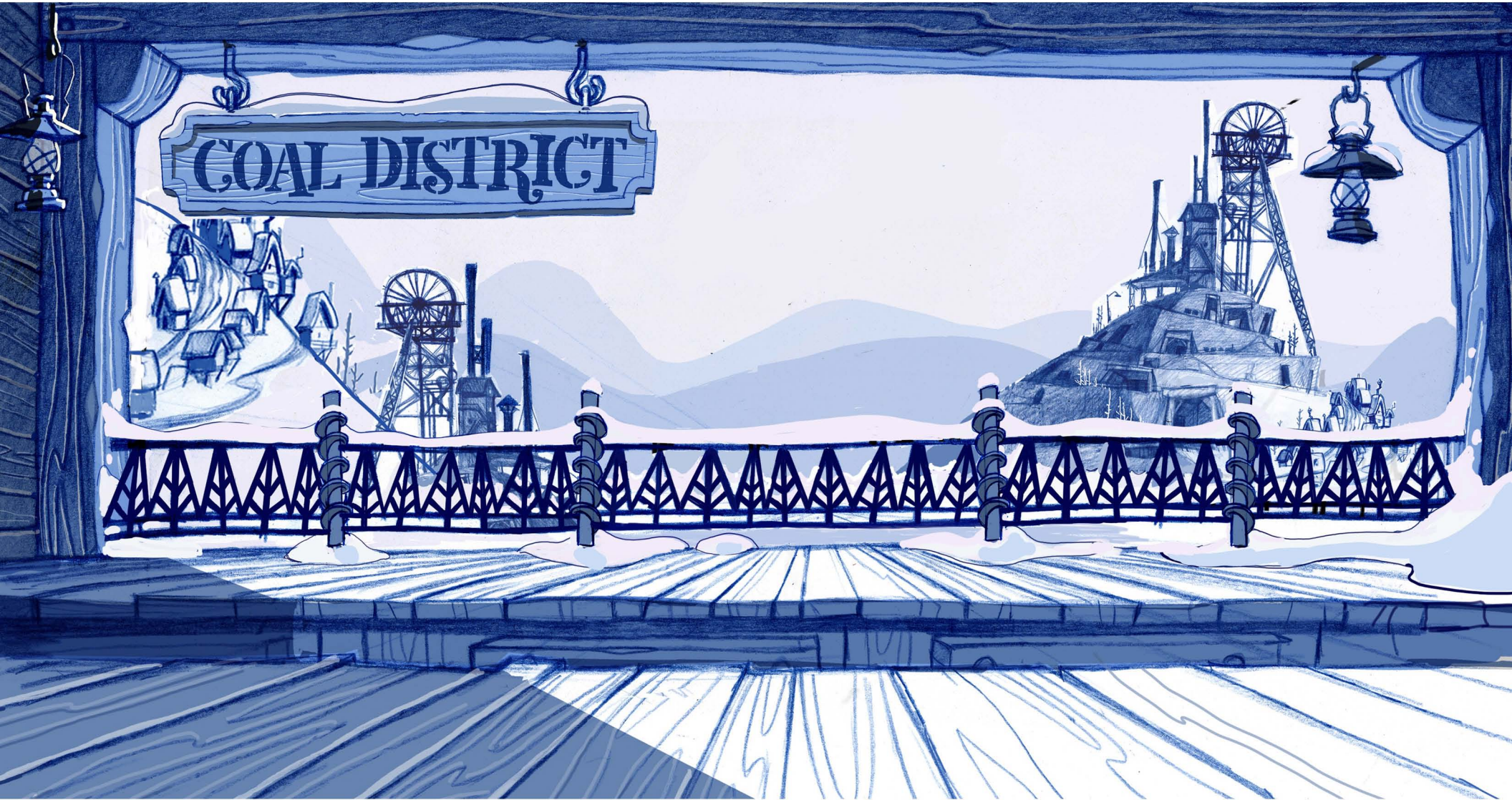

COAL DISTRICT



CHRISTMAS CAROLS



CHRISTMAS CAROLS



CHRISTMAS CAROLS



NORTH POLE GONDOLA

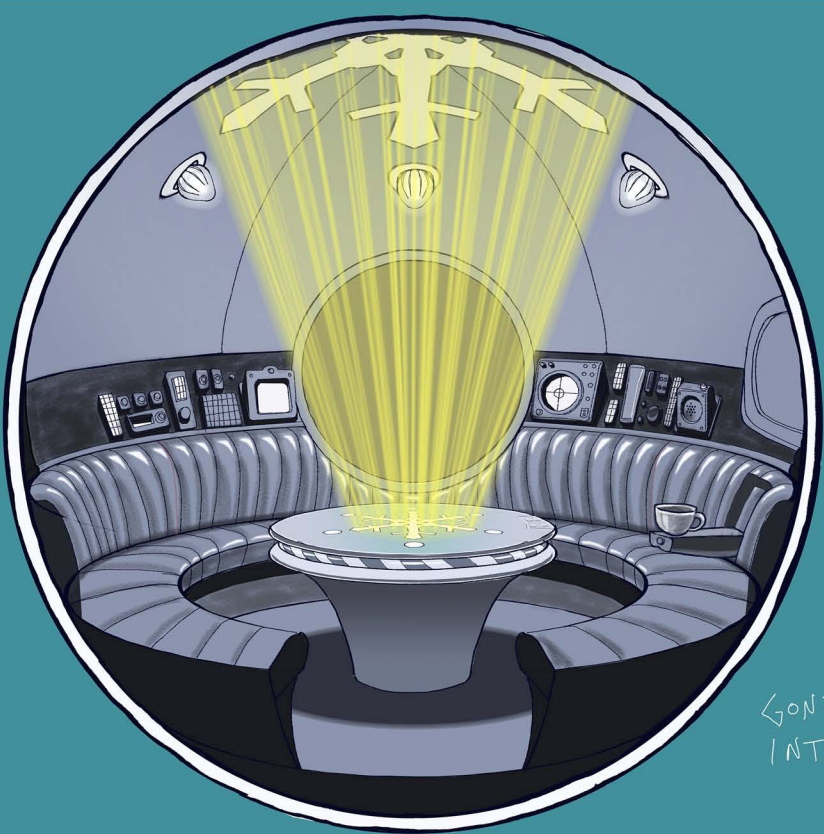

GONDOLA
INTERIOR.



GONDOLA
EXTERIOR.

Prep & LANDING

Gadgets and Gizmos

COAL ELF VEHICLES

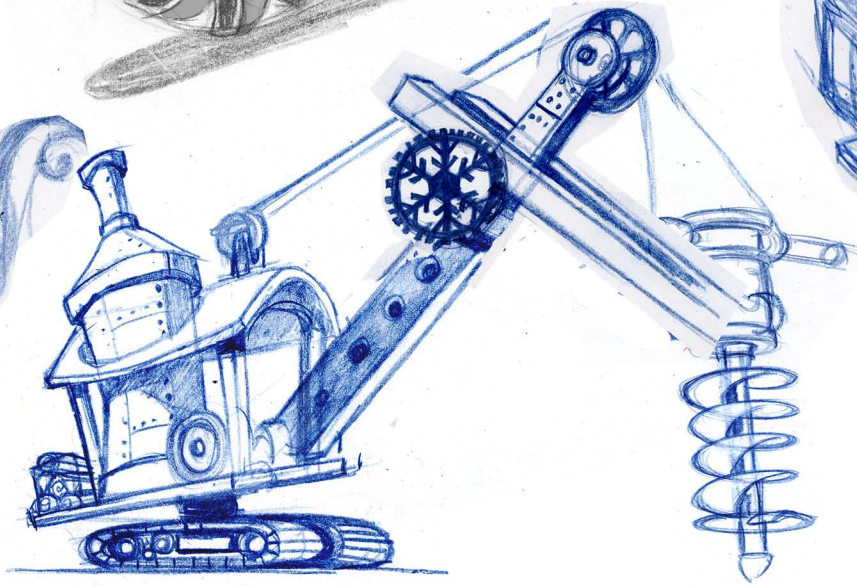
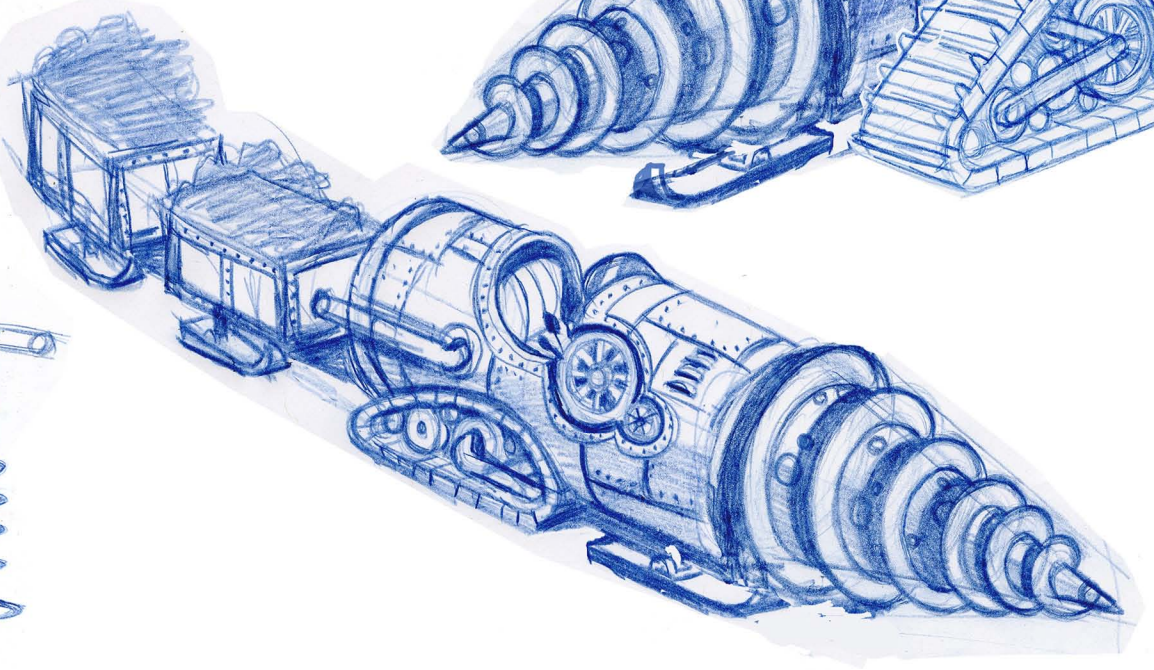
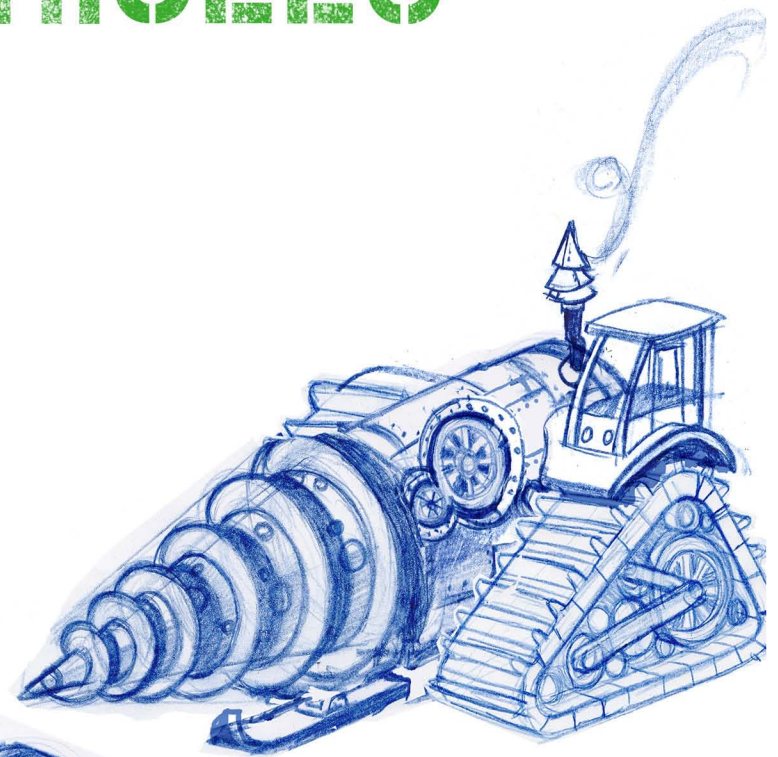
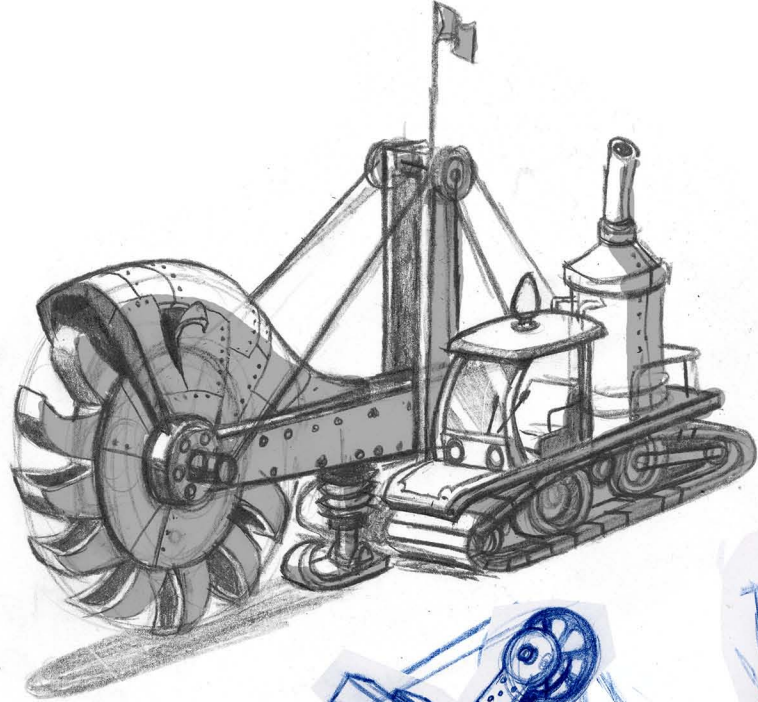

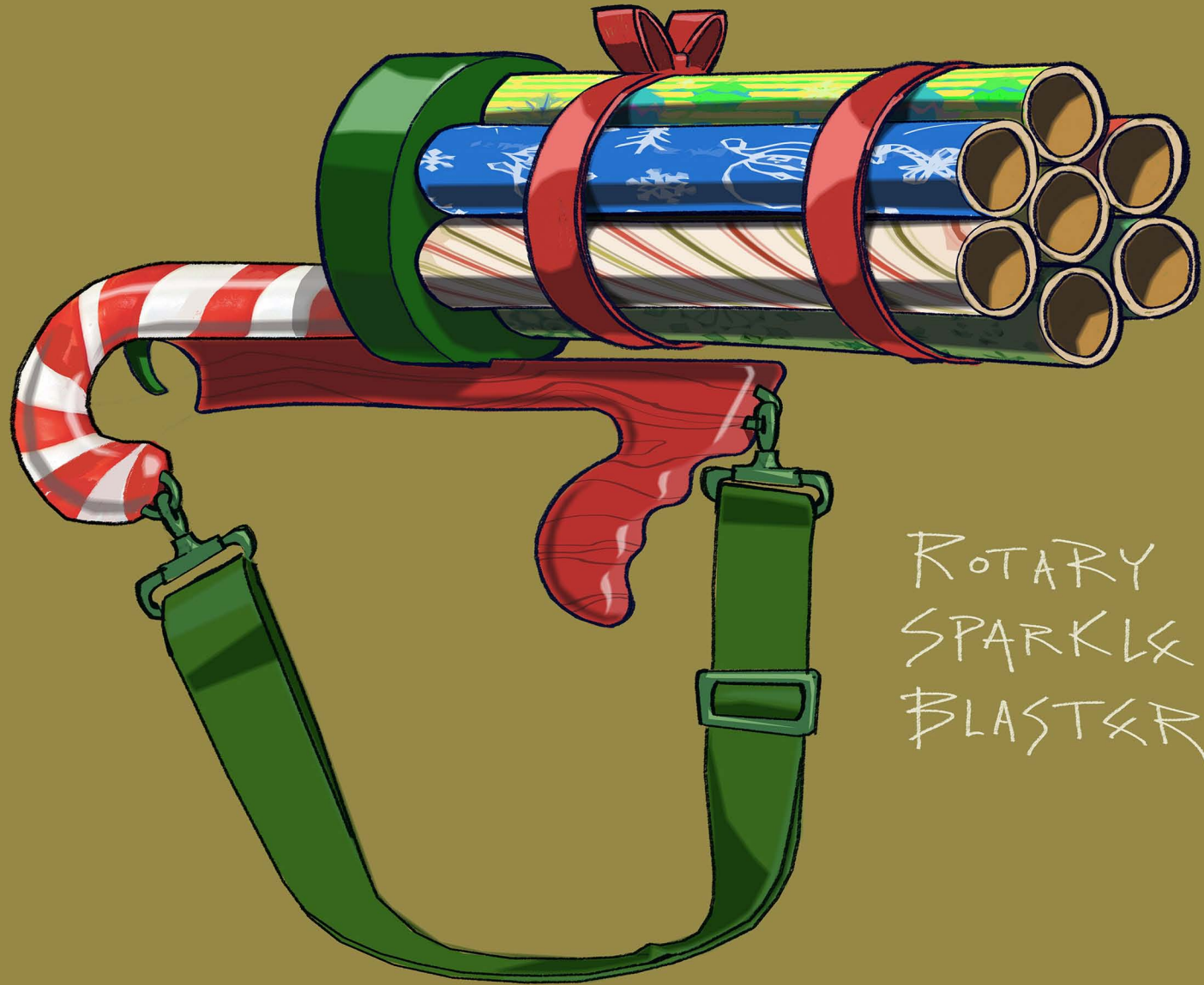

ROTARY
SPARKLE
BLASTER

SKI BOOTS



NORMAL POSITION



SKI MODE

WHEN ACTIVATED, TOES UNFURL INTO SKI TIP

SKI EXTENDS FROM HEEL

FUN NOG MACHINE



ANGEL AIR GUN

DEPRESS BUTTON TO
RELEASE COMPRESSED
AIR BURST



PREP AND LANDING ELF GEAR

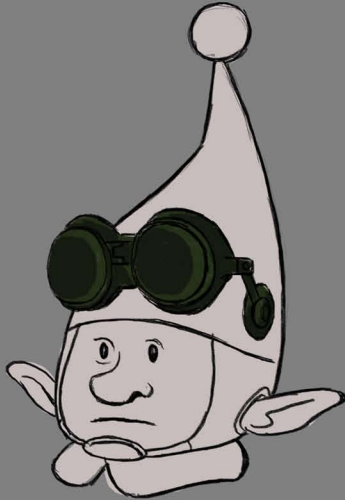

LOCKED POSITION



LOWERED POSITION



NIGHT VISION MODE



TELESCOPIC MODE

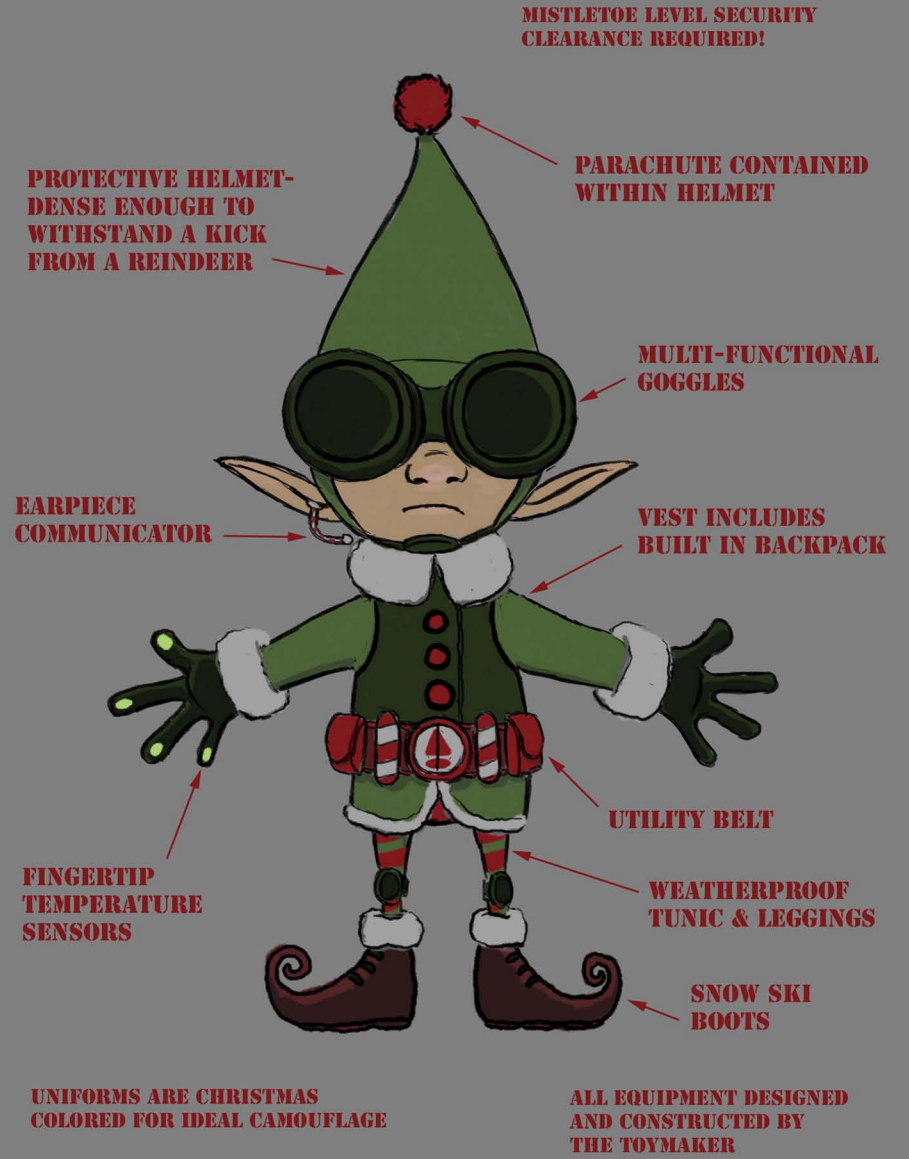

SANTA'S SLEIGH

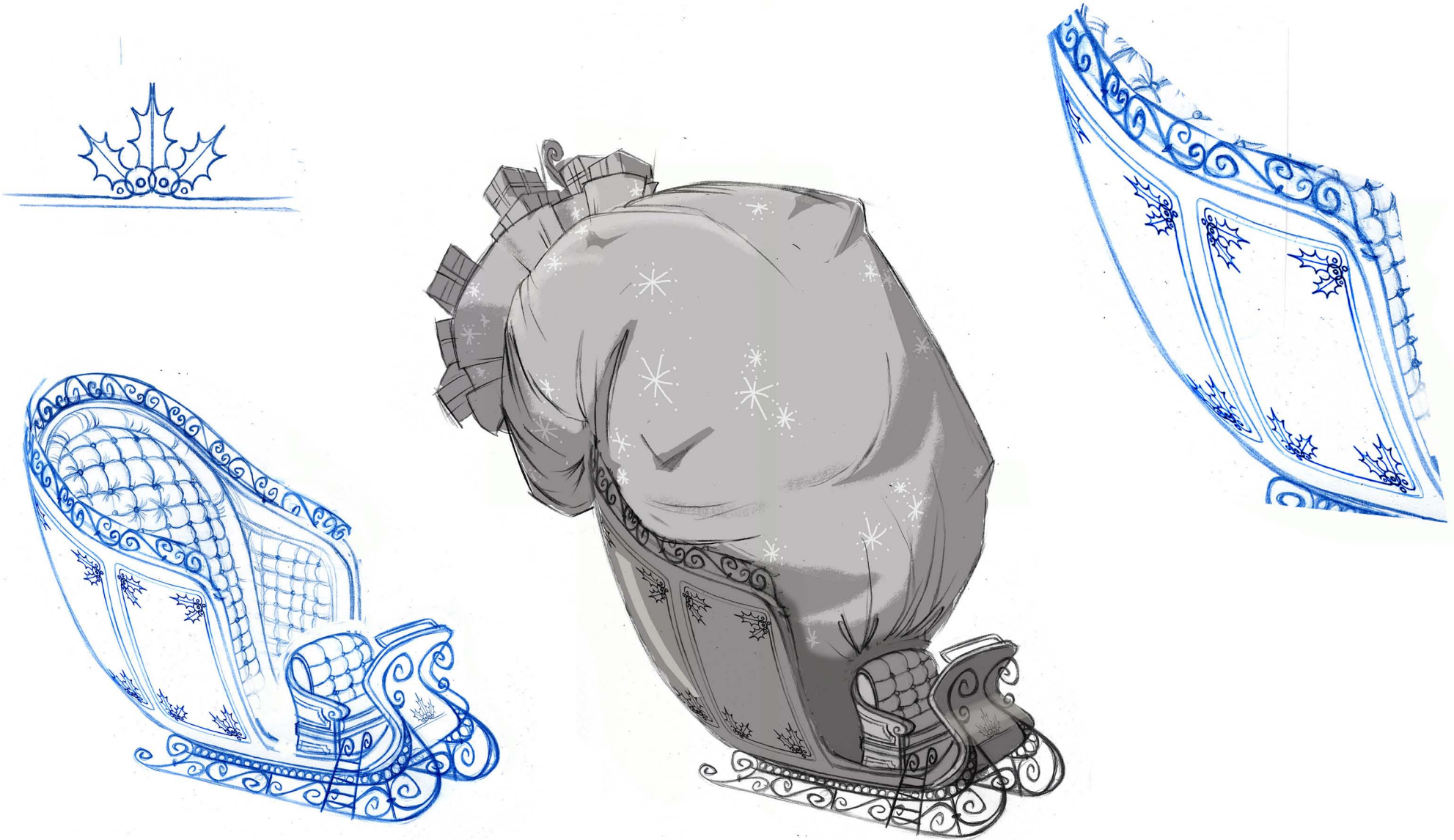

ELF TRANSPORTATION VEHICLE

TOP UP

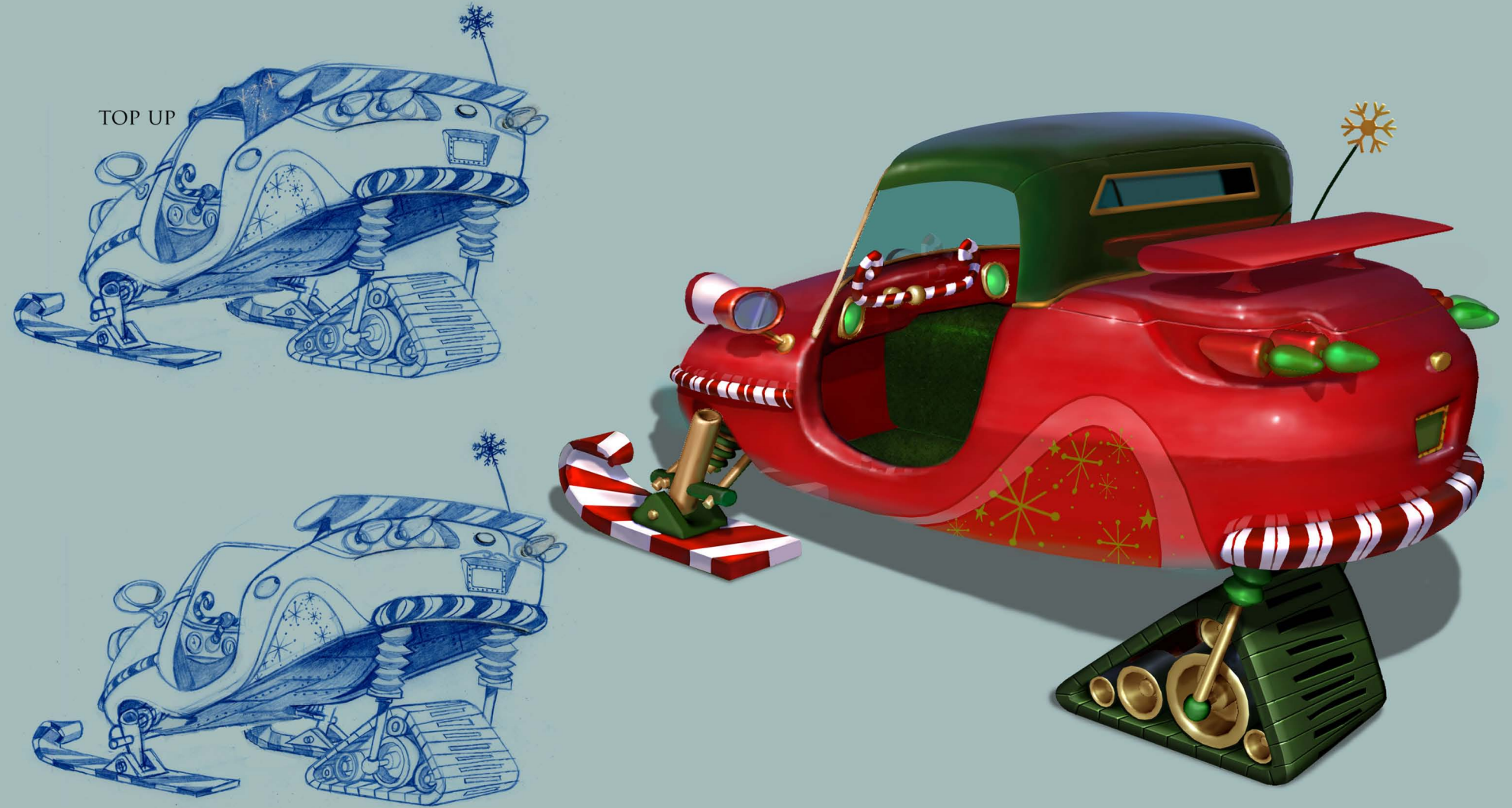

ELF TRANSPORTATION VEHICLE

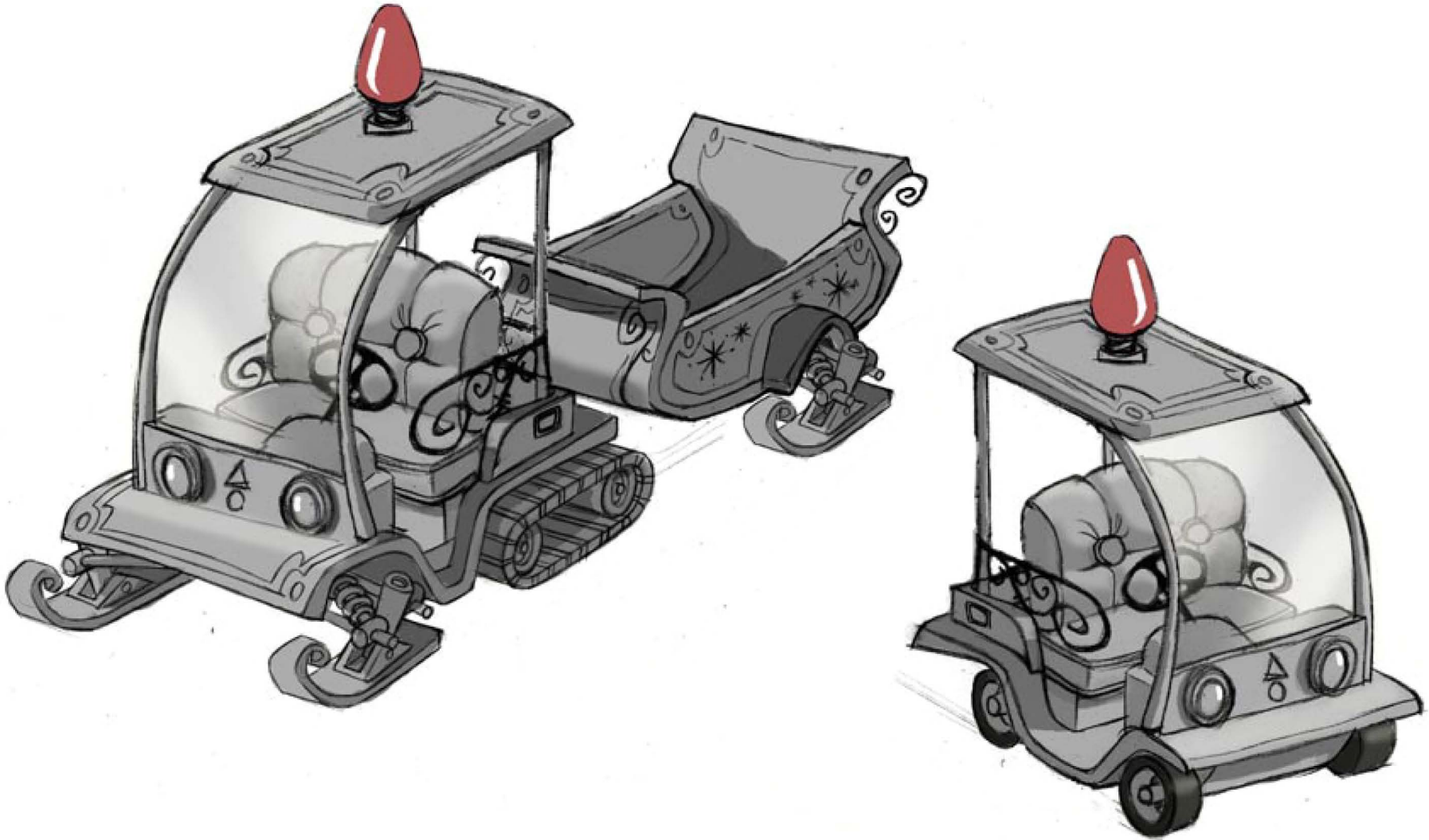

DATABASE TREE FARM EQUIPMENT

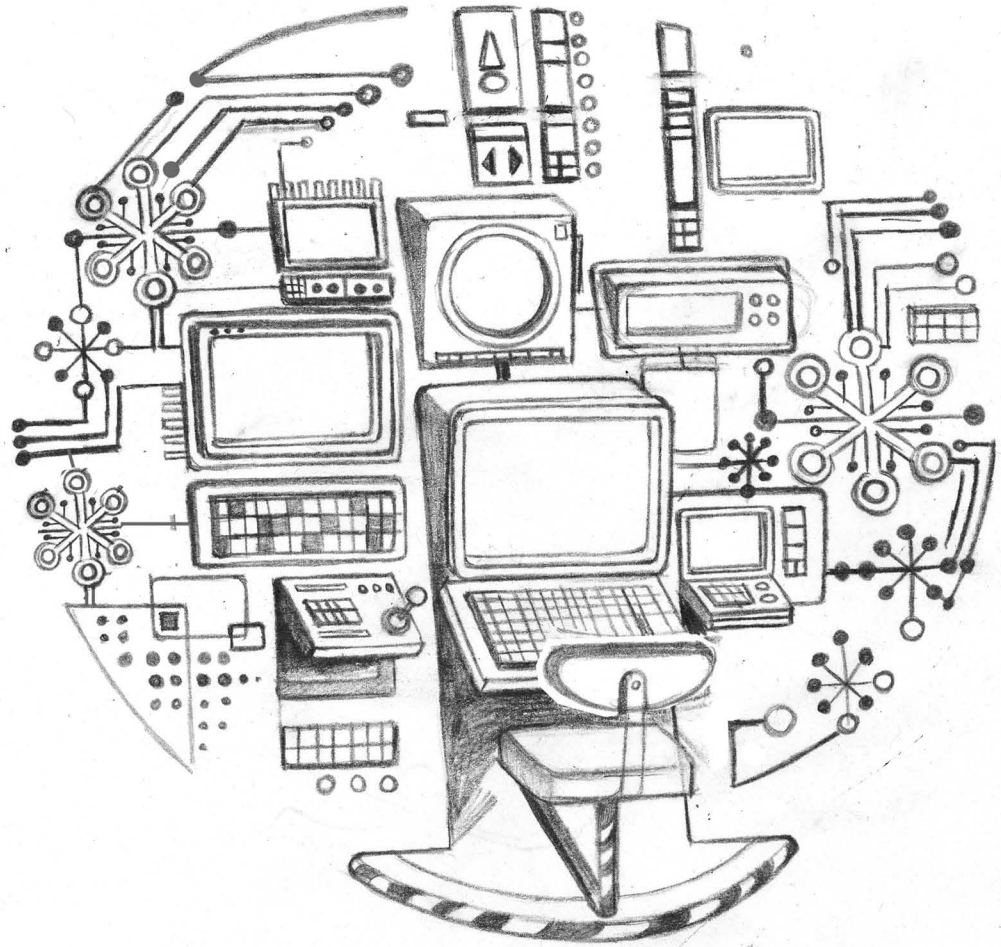
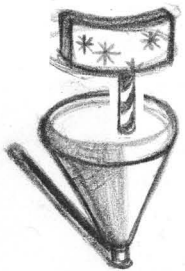
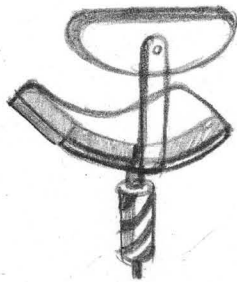

THISTLETON PERSONAL TRANSPORTER

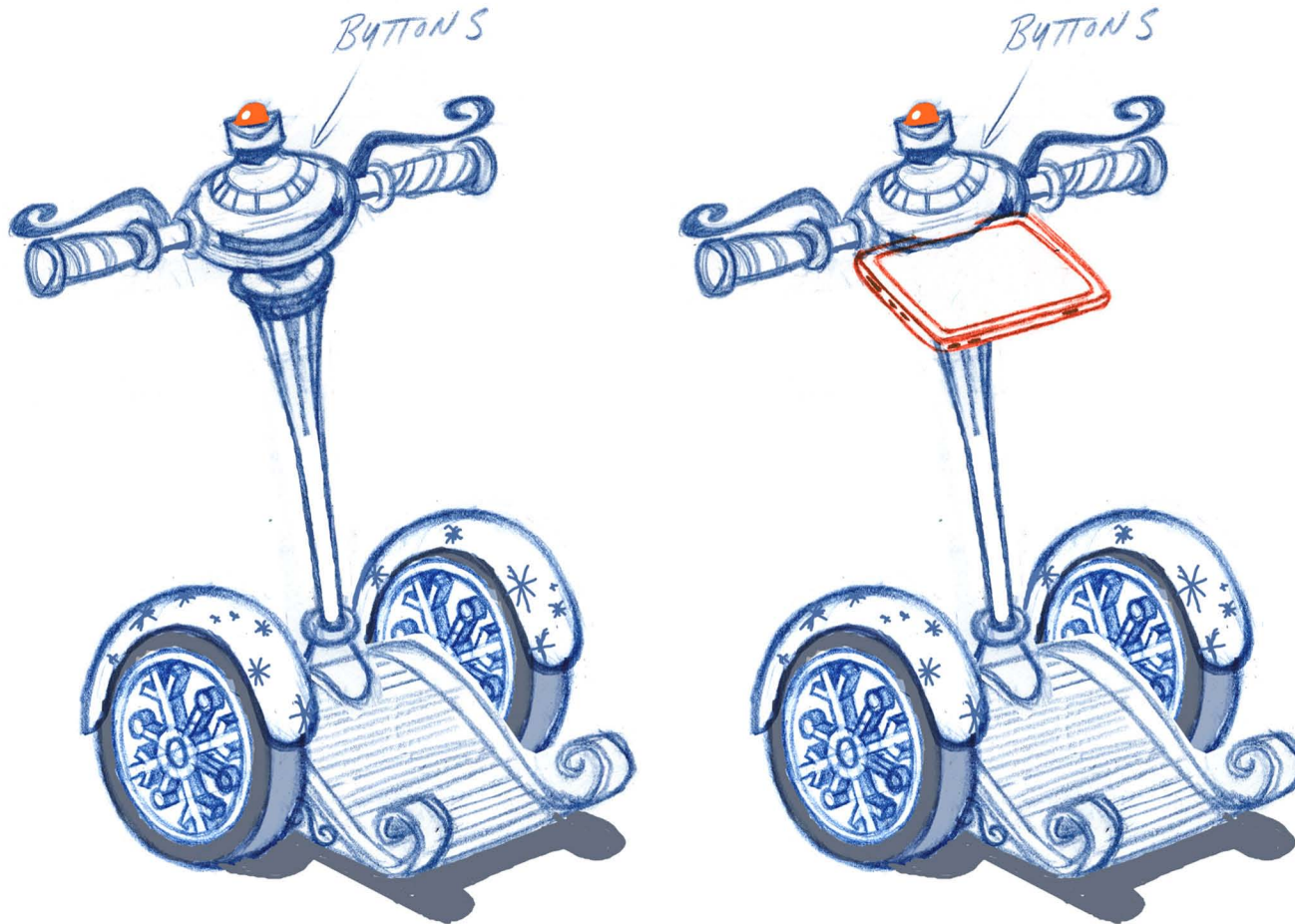

JINGLESMELLI337'S EQUIPMENT

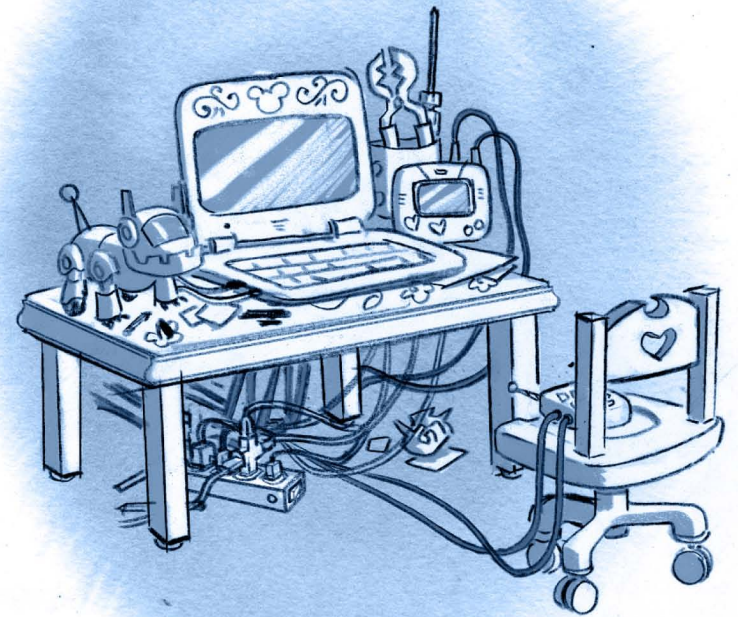
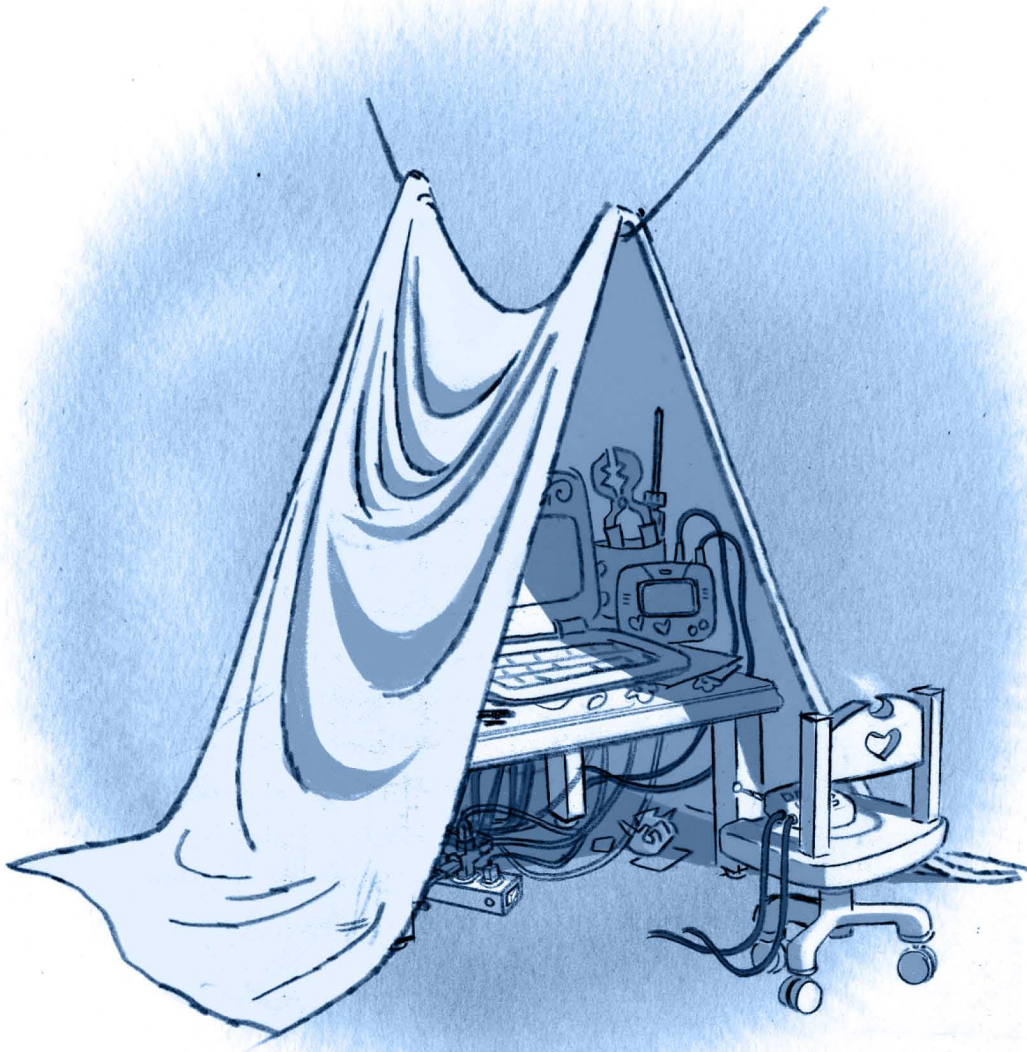

DATABASE TREE FARM SATELLITE

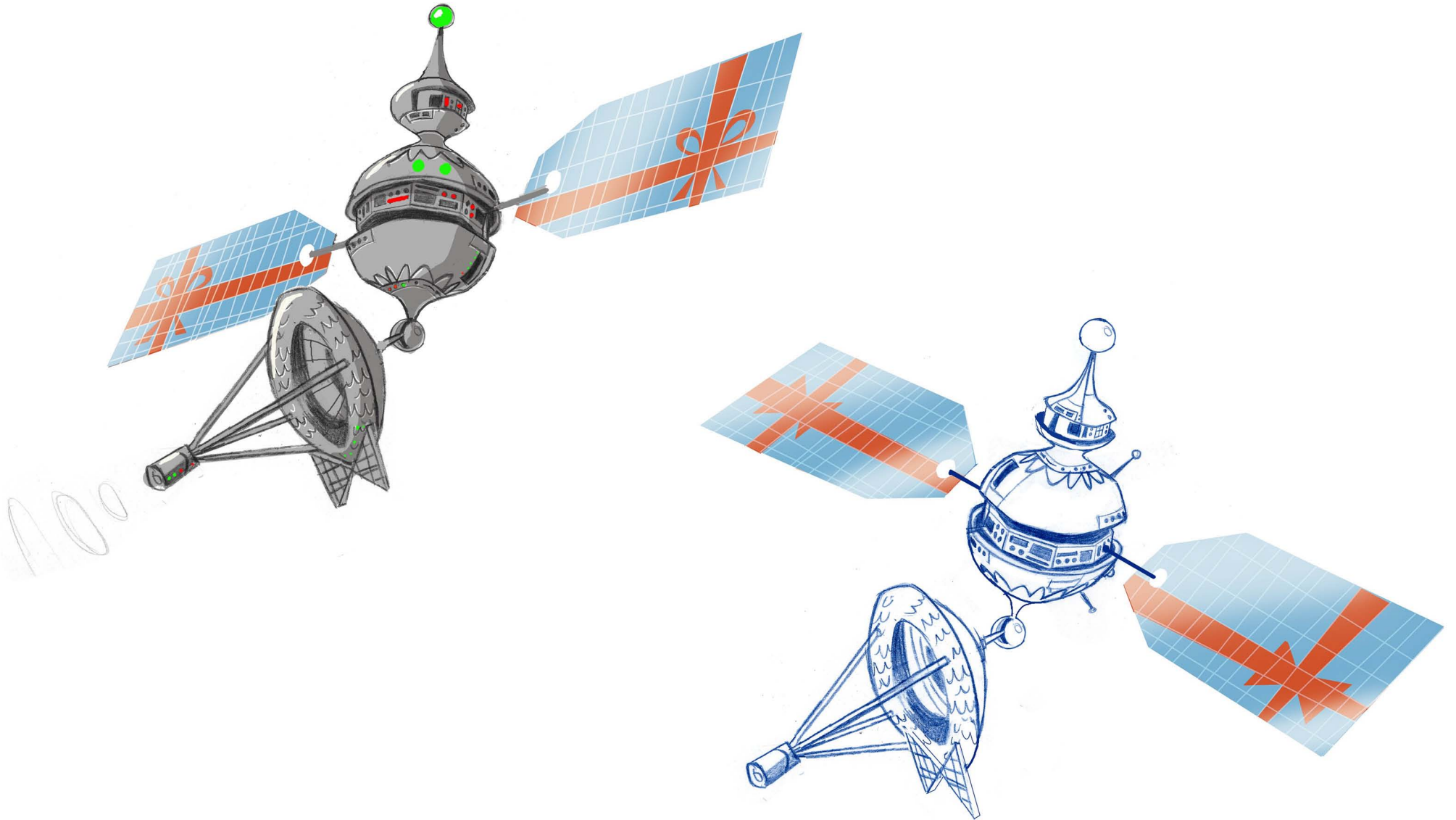

SANTA'S OFFICE EQUIPMENT

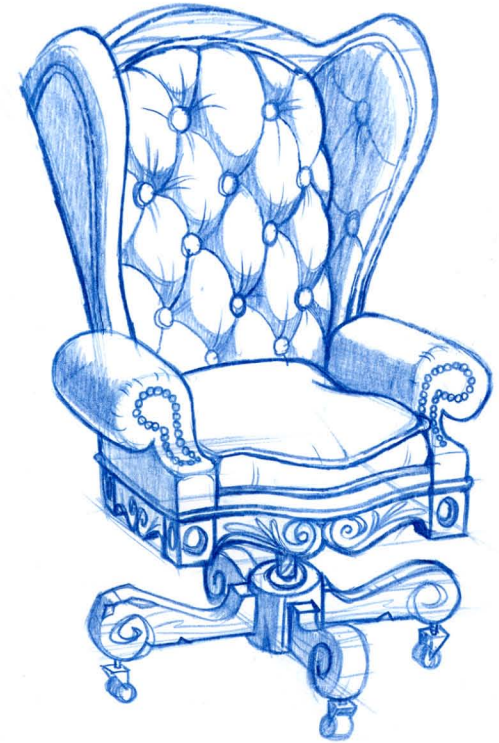
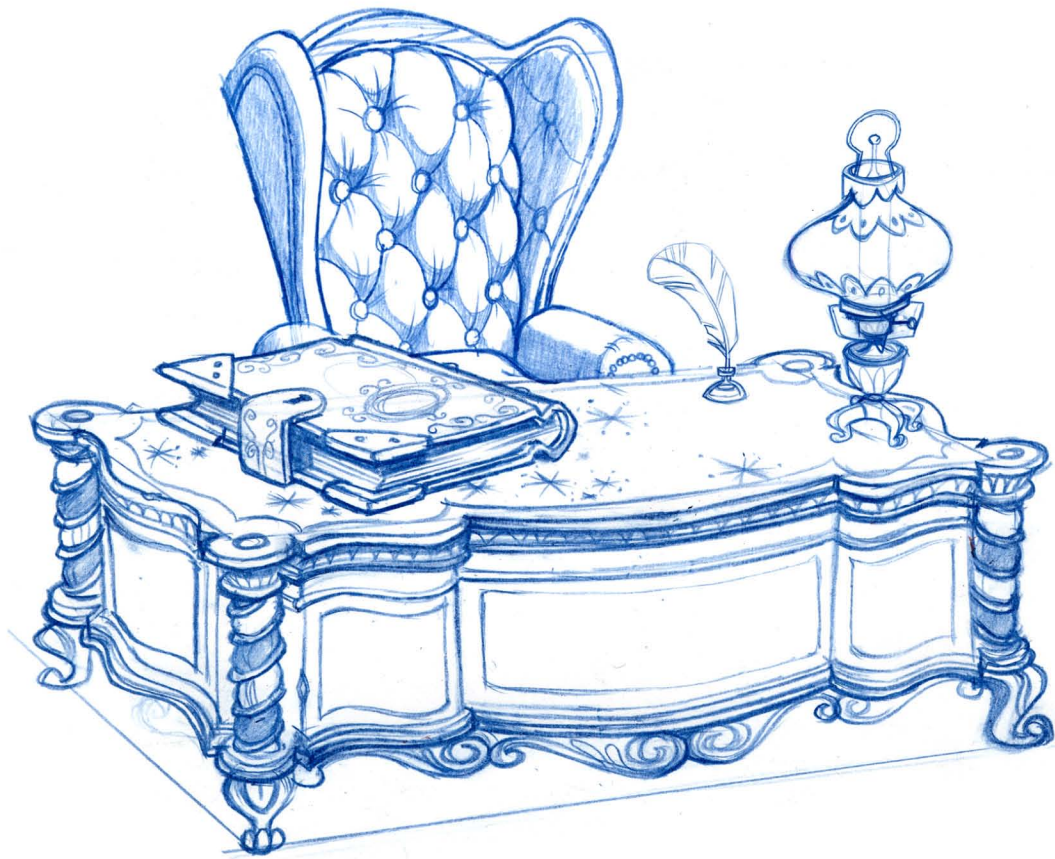

Coal Air Cannon

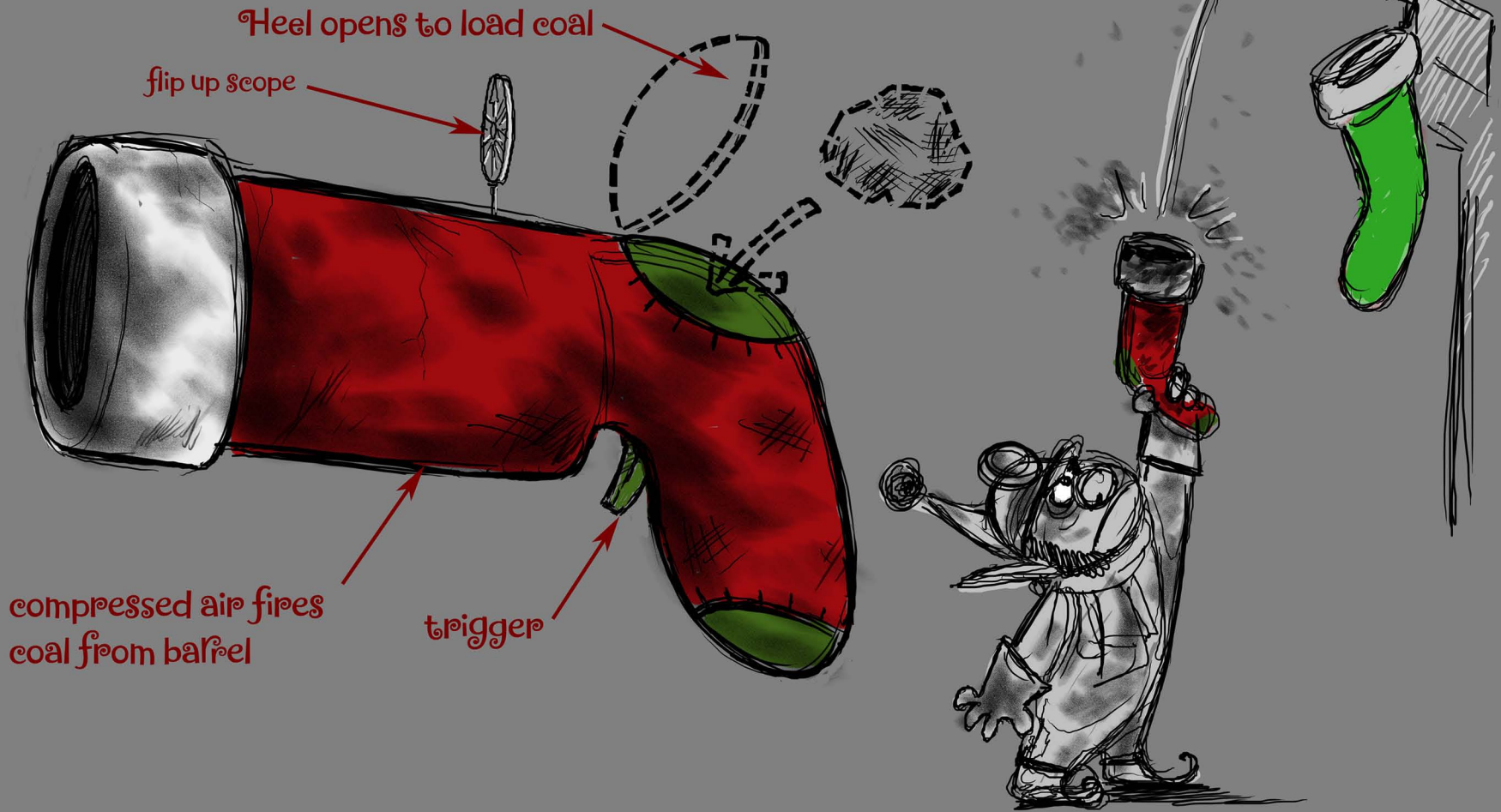

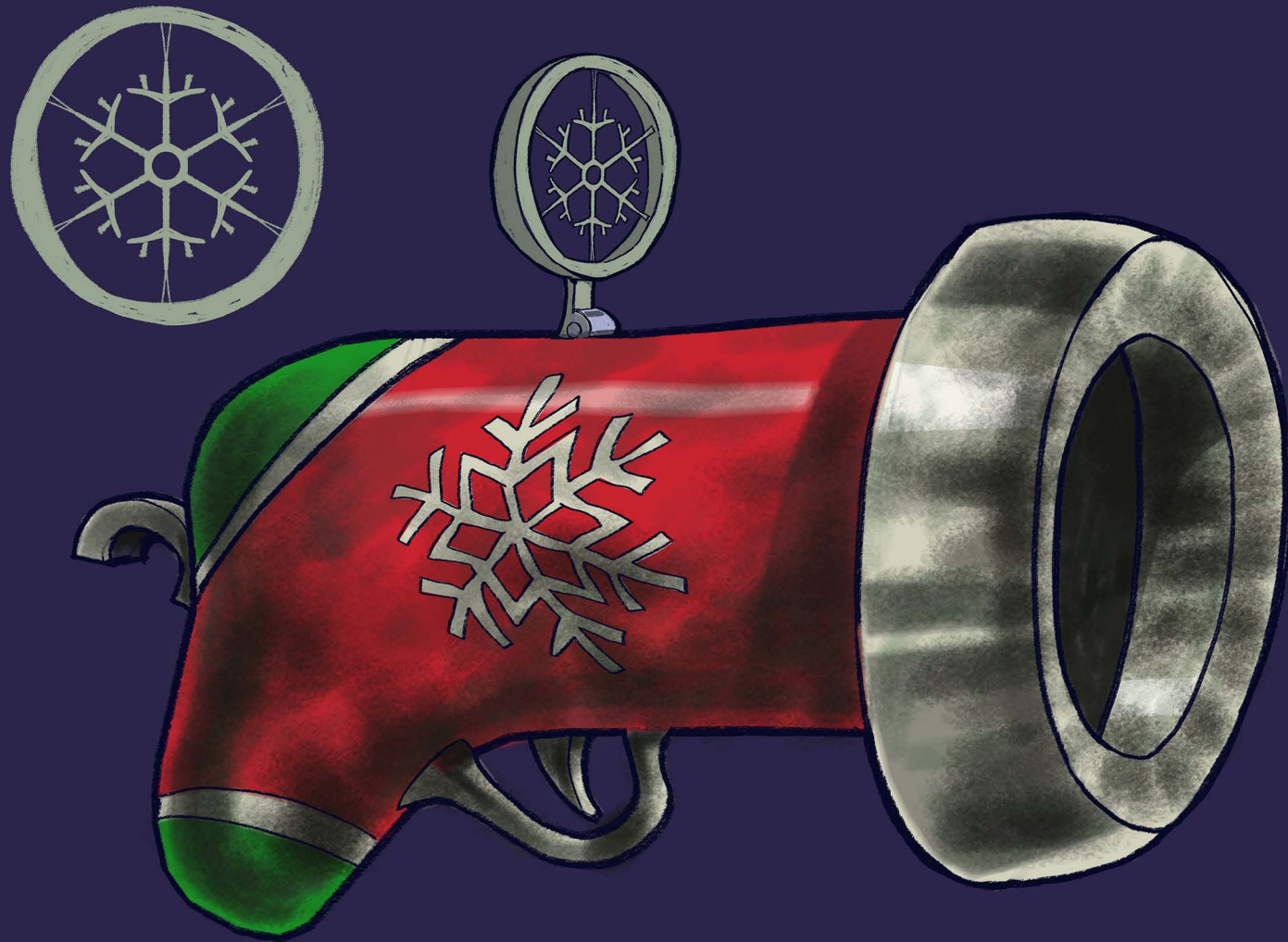

COAL AIR CANNON

FRUITCAKE CONDUCT CALCULATOR



Fruitcake Calculator

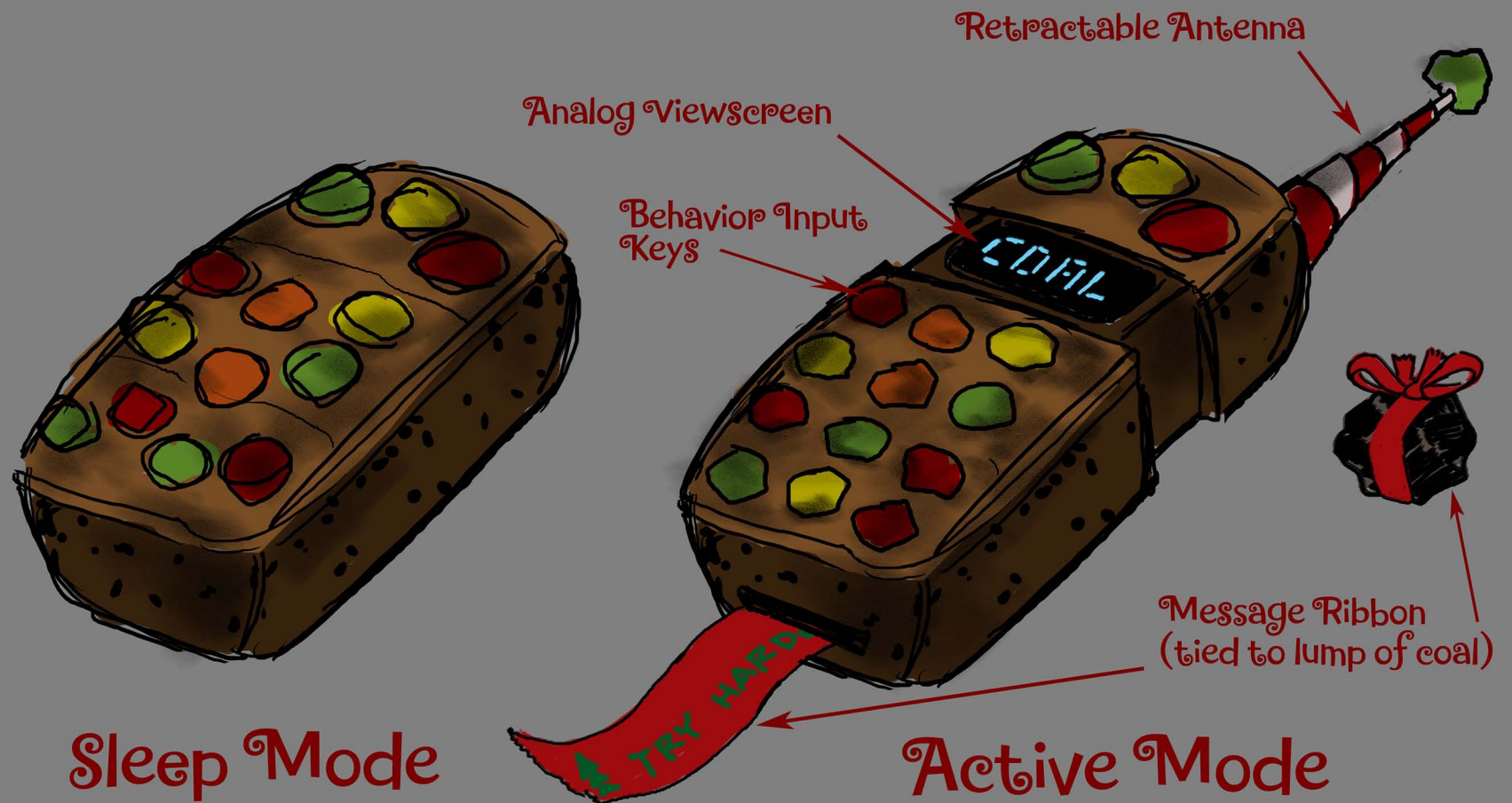

THE G.B.M.

EYE SCANNERS TO DETECT CREATURES STIRRING

SLIDING LOCK BUTTON

TOP VIEW

HEADPHONE JACK

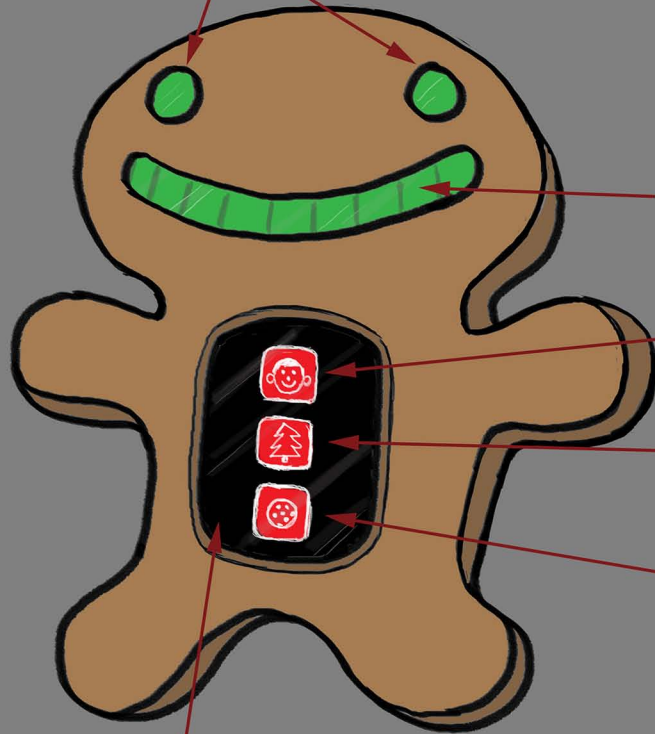

SENSOR BAR

ACCESSES FAMILY PROFILE

ACTIVATES HOLOGRAPHIC GIFT PROJECTOR TO MEASURE TREE CLEARANCE

COOKIE IDENTIFICATION

TOUCHSCREEN



IMAGE PROJECTOR

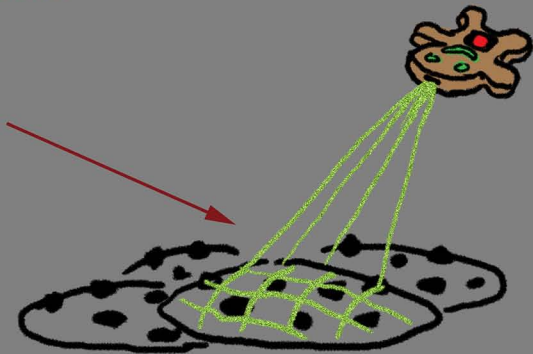

SPARKLE BALL

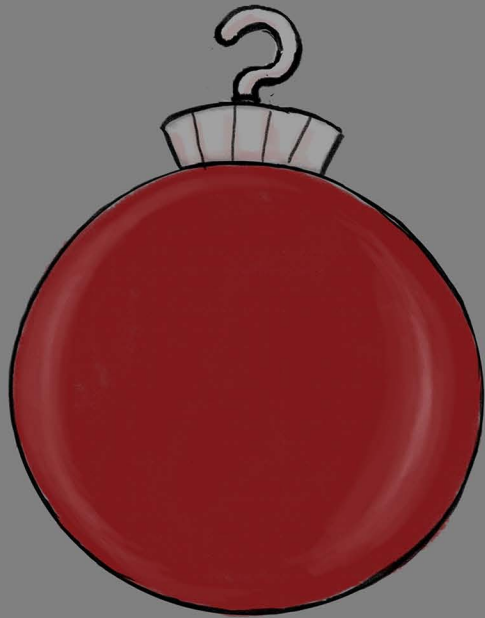

**TO BE USED ONLY IN
EMERGENCY SITUATIONS**

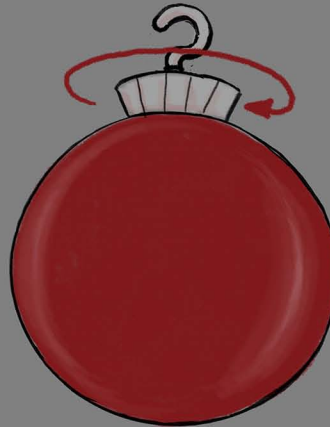

**1. TWIST RING
COUNTERCLOCKWISE**

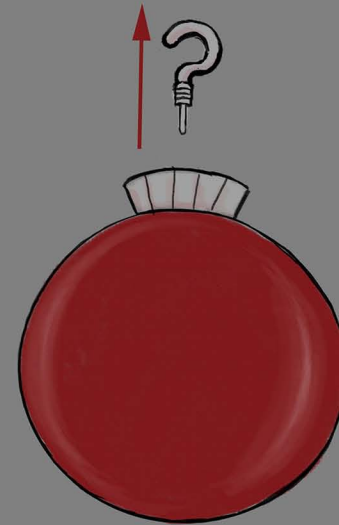

**2. PULL HOOK
UP AND OUT OF RING**

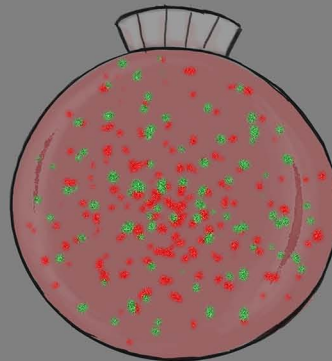

**3. SPARKLE ACTIVATED.
OUTER SHELL DISINTEGRATES-
RELEASE WITHIN 3 SECONDS**

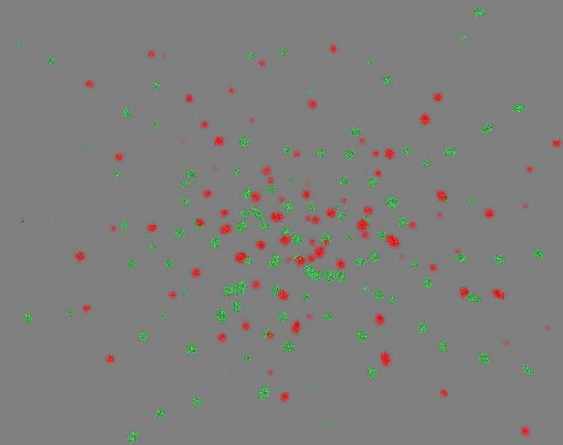

**4. TARGET LULLED INTO
SLEEP BY SPARKLE**

THE SNOWMAN

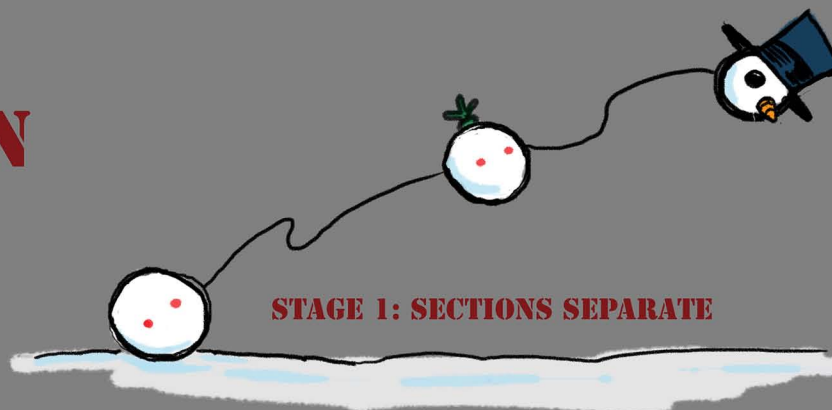

STAGE 1: SECTIONS SEPARATE

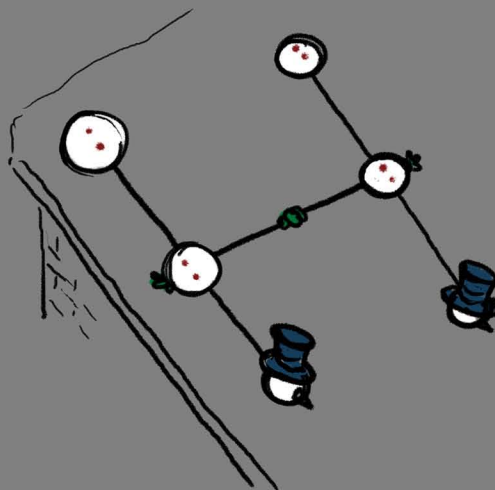

**STAGE 2: CONNECTION LINES TAUT,
HAND EXTENDS AND JOINS WITH
PARTNER SNOWMAN TO FORM
TAILHOOK CABLE**

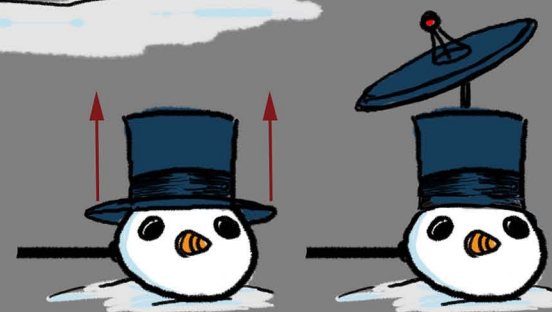

**STAGE 3: HAT BRIM SLIDES UP,
BECOMES RADAR DISH**

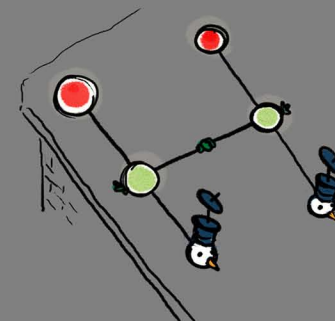

**STAGE 4: LANDING LIGHTS BLINK TO
PROVIDE SAFE RUNWAY FOR SLEIGH**

**SAW EXTENDS FROM
STORAGE IN WRIST
OF GLOVE**

**ACTIVATE BUZZSAW
TO TRIM EXTRANEIOUS
TREE BRANCHES**



SNOWFLAKE SAW

HELMET PARACHUTE

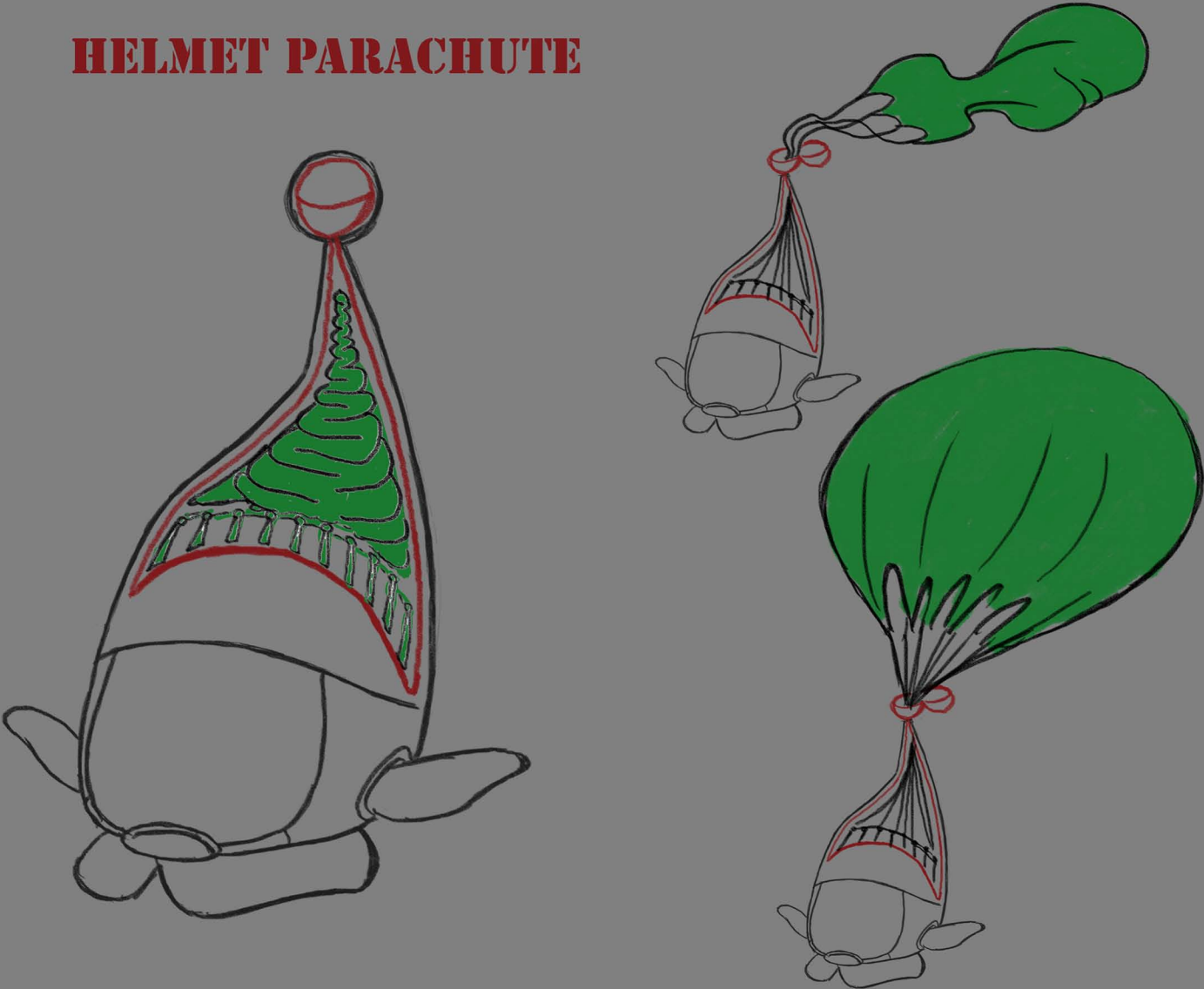

N



#1

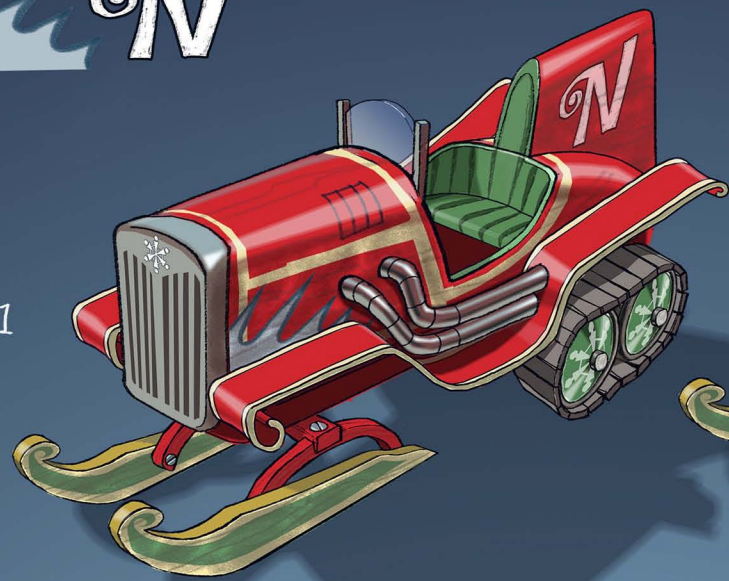

#2

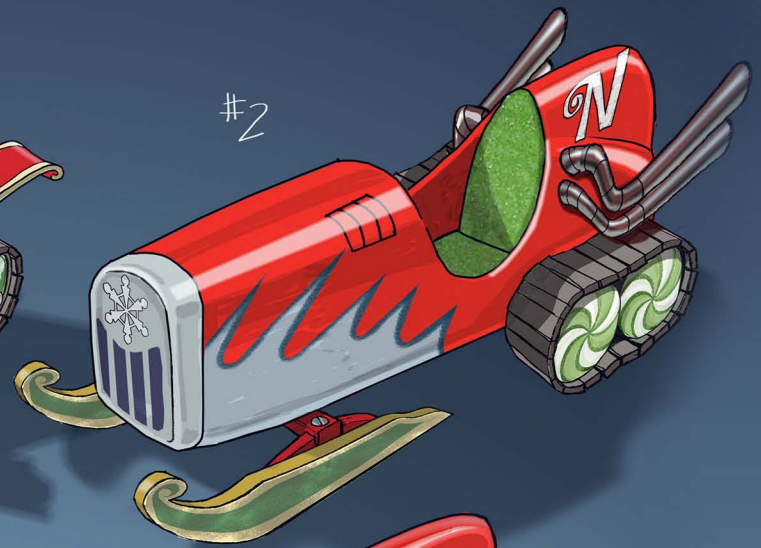

✓ #3

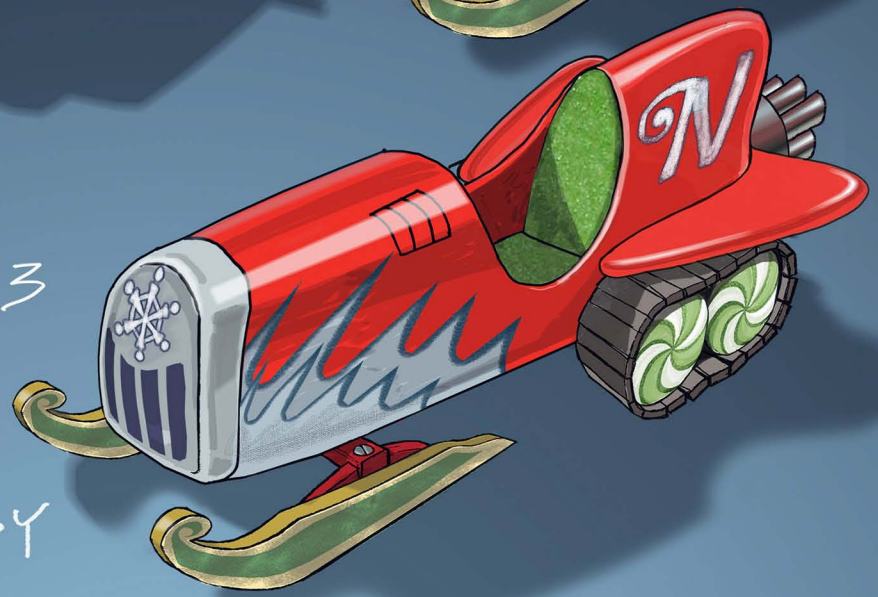

SNOWMOBILE TOY

BU